

**RP07**  
Diagnostic Pathfinder

RP07 PATHFINDER

March 1981

REPRINTED WITH PERMISSION

FROM



## PATHFINDER CHANGE BULLETIN

---

BOOK: ER-0RP07-TM RP07 Pathfinder

REVISION: E I14962-01

EFFECTIVE DATE: January 1, 1983

### INSTRUCTIONS:

#### Remove Pages

109/110

#### Insert Pages

109/110

### NOTE

This Revision to Pathfinder is necessitated by hardware and/or microcode changes to the RP07. This revision will allow Pathfinder to be accurate whether the hardware/microcode changes are installed or not. Please incorporate this Revision immediately.

## MANUAL CONFIGURATION CONTROL INDEX

---

|           |      |  |
|-----------|------|--|
| HC B REV: | A    | All  |
| DATE:     | 3-81 |  |
| HC B REV: | B    | 106, 107, 107A, 107B, TST2041-01                                     |
| DATE:     | 5-81 |  |
| HC B REV: | C    | Revision Page, 2D, 26, 62, 91, 93, 106, 108 thru 113, 120, 139, 166, |
| DATE:     | 4-82 | 177, 209, 231, 267, 346, 348, 361                                    |
| HC B REV: | D    | Revision Page, 122, 131/132, 166, 167                                |
| DATE:     | 7-82 |  |
| HC B REV: | E    | Revision Page, 110   |
| DATE:     | 1-83 |  |

## PATHFINDER INTRODUCTION

The RP07 can diagnose its own symptoms and communicate its findings to the Field Engineer (FE). Pathfinder is a troubleshooting tool designed to complement this ability and is intended to be used in conjunction with RP07 resident microdiagnostics, an oscilloscope, Field Maintenance Print Set, detailed theory of operation found in the Technical Description Manual, functional descriptions and removal and installation instructions found in the Service Manual, and, when necessary in Level III, the Microcode Listings.

Pathfinder uses the Power On Start routine as the entry point to the Fault Isolation Process. It is from this routine that specific tests of Pathfinder are accessed. Pathfinder has three levels.

Level I contains introductory information, initial routines that verify the presence of a fault, and an Error Code Guide Matrix. The Matrix indicates the Field Replaceable Units (FRUs) most likely to have failed. When the specific code in question is displayed, it identifies a diagnostic test to validate the permanent nature of the failure. The text of the diagnostic routine then directs the FE to a Level II test, which will isolate the fault to a specific FRU within the drive.

These Pathfinder Level II routines provide specific step by step instructions that verify the predicted FRU has failed. Fault Isolation techniques that do not require test equipment to identify the malfunctioned FRU are provided whenever possible. When a signal must be measured, the precise point of measurement is provided, and an illustration of the waveform and the test equipment set-up are included.

Pathfinder Level III deals with the incidents that are not able to be validated and verified by Level II. These cases, while infrequent, do occur, and Level III provides as much information as is available to expedite their resolution. Level III includes a brief explanation of the test technique use, a reference to the Microcode Listing for the applicable test, and a list of the most probable causes of the failure. It also provides a cross reference to the chapter and paragraph of the Technical Description Manual that describes the circuitry tested and lists the applicable logic drawing number in the Field Maintenance Print Set.

After reviewing this material, the FE is encouraged to again use the techniques and tests called out in Level II, and to view the results in the light of the information made available through Level III. Should the FE be unable to isolate the fault after having exercised all the options of Pathfinder, the FE is encouraged to pursue all other available resources.



# ERROR CODE GUIDE MATRIX

|          |  | NOT USED AS ERROR CODES<br>USED AS STATE CODES ONLY |    |    |    |    |    |    |    |    |    |    |    |    |    |    |    | DIA0024 |    |    |    |    |    |    |    |    |    |    |    |    |    |    |    | DIA0001 | DIA0024  |    |    |    |    |    |    |    |    |    |    |    |    |    |    |    | DIA0028 | TST2050 | TST2050 | TST2051 | TST2050 | DIA0029 | DIA0025 |  |  |  |  |  |  |  |  |  |  |  |  |  |  |  | DIA002C |  | DIA0031 |  |  |  |  |  | DIA0035 |  |  |  |
|----------|--|---|----|----|----|----|----|----|----|----|----|----|----|----|----|----|----|---------|----|----|----|----|----|----|----|----|----|----|----|----|----|----|----|---------|----------|----|----|----|----|----|----|----|----|----|----|----|----|----|----|----|---------|---------|---------|---------|---------|---------|---------|--|--|--|--|--|--|--|--|--|--|--|--|--|--|--|---------|--|---------|--|--|--|--|--|---------|--|--|--|
|          |  | 00  | 01 | 02 | 03 | 04 | 05 | 06 | 07 | 08 | 09 | 0A | 0B | 0C | 0D | 0E | 0F | 10      | 11 | 12 | 13 | 14 | 15 | 16 | 17 | 18 | 19 | 1A | 1B | 1C | 1D | 1E | 1F | 20      | 21       | 22 | 23 | 24 | 25 | 26 | 27 | 28 | 29 | 2A | 2B | 2C | 2D | 2E | 2F | 30 | 31      | 32      | 33      |         |         |         |         |  |  |  |  |  |  |  |  |  |  |  |  |  |  |  |         |  |         |  |  |  |  |  |         |  |  |  |
| A1A1     |  |   |    |    |    |    |    |    |    |    |    |    |    |    |    |    |    |         |    |    |    |    |    |    |    |    |    |    |    |    |    |    |    |         | A1A1     |    |    |    |    |    |    |    |    |    |    |    |    |    |    |    |         |         |         |         |         |         |         |  |  |  |  |  |  |  |  |  |  |  |  |  |  |  |         |  |         |  |  |  |  |  |         |  |  |  |
| A1A2     |  |   |    |    |    |    |    |    |    |    |    |    |    |    |    |    |    |         |    |    |    |    |    |    |    |    |    |    |    |    |    |    |    |         | A1A2     |    |    |    |    |    |    |    |    |    |    |    |    |    |    |    |         |         |         |         |         |         |         |  |  |  |  |  |  |  |  |  |  |  |  |  |  |  |         |  |         |  |  |  |  |  |         |  |  |  |
| A1A3     |  |   |    |    |    |    |    |    |    |    |    |    |    |    |    |    |    |         |    |    |    |    |    |    |    |    |    |    |    |    |    |    |    |         | A1A3     |    |    |    |    |    |    |    |    |    |    |    |    |    |    |    |         |         |         |         |         |         |         |  |  |  |  |  |  |  |  |  |  |  |  |  |  |  |         |  |         |  |  |  |  |  |         |  |  |  |
| A1A4     |  |   |    |    |    |    |    |    |    |    |    |    |    |    |    |    |    |         |    |    |    |    |    |    |    |    |    |    |    |    |    |    |    |         | A1A4     |    |    |    |    |    |    |    |    |    |    |    |    |    |    |    |         |         |         |         |         |         |         |  |  |  |  |  |  |  |  |  |  |  |  |  |  |  |         |  |         |  |  |  |  |  |         |  |  |  |
| A1A5     |  |   |    |    |    |    |    |    |    |    |    |    |    |    |    |    |    |         |    |    |    |    |    |    |    |    |    |    |    |    |    |    |    |         | A1A5     |    |    |    |    |    |    |    |    |    |    |    |    |    |    |    |         |         |         |         |         |         |         |  |  |  |  |  |  |  |  |  |  |  |  |  |  |  |         |  |         |  |  |  |  |  |         |  |  |  |
| A1A6     |  |   |    |    |    |    |    |    |    |    |    |    |    |    |    |    |    |         |    |    |    |    |    |    |    |    |    |    |    |    |    |    |    |         | A1A6     |    |    |    |    |    |    |    |    |    |    |    |    |    |    |    |         |         |         |         |         |         |         |  |  |  |  |  |  |  |  |  |  |  |  |  |  |  |         |  |         |  |  |  |  |  |         |  |  |  |
| A1A7     |  |   |    |    |    |    |    |    |    |    |    |    |    |    |    |    |    |         |    |    |    |    |    |    |    |    |    |    |    |    |    |    |    |         | A1A7     |    |    |    |    |    |    |    |    |    |    |    |    |    |    |    |         |         |         |         |         |         |         |  |  |  |  |  |  |  |  |  |  |  |  |  |  |  |         |  |         |  |  |  |  |  |         |  |  |  |
| A1A8     |  |   |    |    |    |    |    |    |    |    |    |    |    |    |    |    |    |         |    |    |    |    |    |    |    |    |    |    |    |    |    |    |    |         | A1A8     |    |    |    |    |    |    |    |    |    |    |    |    |    |    |    |         |         |         |         |         |         |         |  |  |  |  |  |  |  |  |  |  |  |  |  |  |  |         |  |         |  |  |  |  |  |         |  |  |  |
| A1A9     |  |   |    |    |    |    |    |    |    |    |    |    |    |    |    |    |    |         |    |    |    |    |    |    |    |    |    |    |    |    |    |    |    |         | A1A9     |    |    |    |    |    |    |    |    |    |    |    |    |    |    |    |         |         |         |         |         |         |         |  |  |  |  |  |  |  |  |  |  |  |  |  |  |  |         |  |         |  |  |  |  |  |         |  |  |  |
| A1A10    |  |   |    |    |    |    |    |    |    |    |    |    |    |    |    |    |    |         |    |    |    |    |    |    |    |    |    |    |    |    |    |    |    |         | A1A10    |    |    |    |    |    |    |    |    |    |    |    |    |    |    |    |         |         |         |         |         |         |         |  |  |  |  |  |  |  |  |  |  |  |  |  |  |  |         |  |         |  |  |  |  |  |         |  |  |  |
| A1A11/13 |  |   |    |    |    |    |    |    |    |    |    |    |    |    |    |    |    |         |    |    |    |    |    |    |    |    |    |    |    |    |    |    |    |         | A1A11/13 |    |    |    |    |    |    |    |    |    |    |    |    |    |    |    |         |         |         |         |         |         |         |  |  |  |  |  |  |  |  |  |  |  |  |  |  |  |         |  |         |  |  |  |  |  |         |  |  |  |
| A1A12    |  |   |    |    |    |    |    |    |    |    |    |    |    |    |    |    |    |         |    |    |    |    |    |    |    |    |    |    |    |    |    |    |    |         | A1A12    |    |    |    |    |    |    |    |    |    |    |    |    |    |    |    |         |         |         |         |         |         |         |  |  |  |  |  |  |  |  |  |  |  |  |  |  |  |         |  |         |  |  |  |  |  |         |  |  |  |
| A1A14    |  |   |    |    |    |    |    |    |    |    |    |    |    |    |    |    |    |         |    |    |    |    |    |    |    |    |    |    |    |    |    |    |    |         | A1A14    |    |    |    |    |    |    |    |    |    |    |    |    |    |    |    |         |         |         |         |         |         |         |  |  |  |  |  |  |  |  |  |  |  |  |  |  |  |         |  |         |  |  |  |  |  |         |  |  |  |
| A1A15    |  |   |    |    |    |    |    |    |    |    |    |    |    |    |    |    |    |         |    |    |    |    |    |    |    |    |    |    |    |    |    |    |    |         | A1A15    |    |    |    |    |    |    |    |    |    |    |    |    |    |    |    |         |         |         |         |         |         |         |  |  |  |  |  |  |  |  |  |  |  |  |  |  |  |         |  |         |  |  |  |  |  |         |  |  |  |
| A1A16    |  |   |    |    |    |    |    |    |    |    |    |    |    |    |    |    |    |         |    |    |    |    |    |    |    |    |    |    |    |    |    |    |    |         | A1A16    |    |    |    |    |    |    |    |    |    |    |    |    |    |    |    |         |         |         |         |         |         |         |  |  |  |  |  |  |  |  |  |  |  |  |  |  |  |         |  |         |  |  |  |  |  |         |  |  |  |
| A1A17    |  |   |    |    |    |    |    |    |    |    |    |    |    |    |    |    |    |         |    |    |    |    |    |    |    |    |    |    |    |    |    |    |    |         | A1A17    |    |    |    |    |    |    |    |    |    |    |    |    |    |    |    |         |         |         |         |         |         |         |  |  |  |  |  |  |  |  |  |  |  |  |  |  |  |         |  |         |  |  |  |  |  |         |  |  |  |
| A1A20    |  |   |    |    |    |    |    |    |    |    |    |    |    |    |    |    |    |         |    |    |    |    |    |    |    |    |    |    |    |    |    |    |    |         | A1A20    |    |    |    |    |    |    |    |    |    |    |    |    |    |    |    |         |         |         |         |         |         |         |  |  |  |  |  |  |  |  |  |  |  |  |  |  |  |         |  |         |  |  |  |  |  |         |  |  |  |
| A1A21    |  |   |    |    |    |    |    |    |    |    |    |    |    |    |    |    |    |         |    |    |    |    |    |    |    |    |    |    |    |    |    |    |    |         | A1A21    |    |    |    |    |    |    |    |    |    |    |    |    |    |    |    |         |         |         |         |         |         |         |  |  |  |  |  |  |  |  |  |  |  |  |  |  |  |         |  |         |  |  |  |  |  |         |  |  |  |
| HDA      |  |   |    |    |    |    |    |    |    |    |    |    |    |    |    |    |    |         |    |    |    |    |    |    |    |    |    |    |    |    |    |    |    |         | HDA      |    |    |    |    |    |    |    |    |    |    |    |    |    |    |    |         |         |         |         |         |         |         |  |  |  |  |  |  |  |  |  |  |  |  |  |  |  |         |  |         |  |  |  |  |  |         |  |  |  |





# ERROR CODE GUIDE MATRIX

|                      | DIA0018 | DIA0036 | TST206A | DIA0035 & DIA0023 | DIA0030 | DIA002B | DIA002E | DIA002F | DIA0034 | DIA0001 | DIA0036 | TST2087 | DIA0088 | DIA001A | DIA0019 | DIA001A | DIA0023 | DIA0039 |    |    |    |    |    |    |    |    |    |    |    |    |    |    |    |    |    |    |    |    |    |    |    |    |    |    |    |    |    |    |    |    |    |    |  |  |
|----------------------|---------|---------|---------|-------------------|---------|---------|---------|---------|---------|---------|---------|---------|---------|---------|---------|---------|---------|---------|----|----|----|----|----|----|----|----|----|----|----|----|----|----|----|----|----|----|----|----|----|----|----|----|----|----|----|----|----|----|----|----|----|----|--|--|
|                      | 68      | 69      | 6A      | 6B                | 6C      | 6D      | 6E      | 6F      | 70      | 71      | 72      | 73      | 74      | 75      | 76      | 77      | 78      | 79      | 7A | 7B | 7C | 7D | 7E | 7F | 80 | 81 | 82 | 83 | 84 | 85 | 86 | 87 | 88 | 89 | 8A | 8B | 8C | 8D | 8E | 8F | 90 | 91 | 92 | 93 | 94 | 95 | 96 | 97 | 98 | 99 | 9A | 9B |  |  |
| A1A1                 |         |         |         |                   |         |         |         |         |         |         |         |         |         |         |         |         |         |         |    |    |    |    |    |    |    |    |    |    |    |    |    |    |    |    |    |    |    |    |    |    |    |    |    |    |    |    |    |    |    |    |    |    |  |  |
| A1A2                 |         |         |         |                   |         |         |         |         |         |         | X       | X       |         |         |         |         |         |         |    |    |    |    |    |    |    |    |    |    |    |    |    |    |    |    |    |    |    |    |    |    |    |    |    |    |    |    |    |    |    |    |    |    |  |  |
| A1A3                 |         |         |         |                   |         |         |         |         |         |         |         |         |         |         |         |         |         |         |    |    |    |    |    |    |    |    |    |    |    |    |    |    |    |    |    |    |    |    |    |    |    |    |    |    |    |    |    |    |    |    |    |    |  |  |
| A1A4                 | X       |         |         |                   |         |         |         |         | X       | X       | X       | X       |         |         |         |         |         |         |    |    |    |    |    |    |    |    |    |    |    |    |    |    |    |    |    |    |    |    |    |    |    |    |    |    |    |    |    |    |    |    |    |    |  |  |
| A1A5                 |         |         |         |                   | X       | X       | X       | X       | X       | X       | X       | X       | X       | X       | X       | X       | X       | X       | X  | X  | X  | X  | X  | X  | X  | X  |    |    |    |    |    |    |    |    |    |    |    |    |    |    |    |    |    |    |    |    |    |    |    |    |    |    |  |  |
| A1A6                 | X       |         |         |                   | X       | X       | X       | X       | X       | X       | X       | X       | X       | X       | X       | X       | X       | X       | X  | X  | X  | X  | X  | X  |    |    |    |    |    |    |    |    |    |    |    |    |    |    |    |    |    |    |    |    |    |    |    |    |    |    |    |    |  |  |
| A1A7                 |         |         |         |                   | X       | X       | X       | X       | X       | X       |         |         |         |         |         |         |         |         |    |    |    |    |    |    |    |    | X  |    |    |    |    |    |    |    |    |    |    |    |    |    |    |    |    |    |    |    |    |    |    |    |    |    |  |  |
| A1A8                 |         | X       | X       |                   | X       | X       | X       | X       | X       | X       | X       | X       | X       | X       | X       | X       | X       | X       | X  | X  | X  | X  | X  | X  | X  | X  | X  | X  | X  | X  | X  | X  | X  | X  | X  | X  | X  | X  | X  | X  | X  | X  | X  | X  | X  | X  | X  | X  | X  | X  | X  |    |  |  |
| A1A9                 |         | X       | X       |                   | X       | X       | X       | X       | X       | X       | X       | X       | X       | X       | X       | X       | X       | X       | X  | X  | X  | X  | X  | X  | X  | X  | X  | X  | X  | X  | X  | X  | X  | X  | X  | X  | X  | X  | X  | X  | X  | X  | X  | X  | X  | X  | X  | X  | X  | X  | X  |    |  |  |
| A1A10                |         |         |         | X                 | X       | X       | X       | X       | X       | X       | X       | X       | X       | X       | X       | X       | X       | X       | X  | X  | X  | X  | X  | X  | X  | X  | X  | X  | X  | X  | X  | X  | X  | X  | X  | X  | X  | X  | X  | X  | X  | X  | X  | X  | X  | X  | X  | X  | X  | X  | X  |    |  |  |
| A1A11/13             |         |         | X       |                   |         |         |         |         |         |         |         |         |         |         |         |         |         |         |    |    |    |    |    |    |    |    |    |    |    |    |    |    |    |    |    |    |    |    |    |    |    |    |    |    |    |    |    |    |    |    |    |    |  |  |
| A1A12                |         |         | X       |                   |         |         |         |         |         |         |         |         |         |         |         |         |         |         |    |    |    |    |    |    |    |    | X  | X  | X  | X  | X  | X  | X  | X  | X  | X  | X  | X  | X  | X  | X  | X  | X  | X  | X  | X  | X  | X  | X  | X  | X  | X  |  |  |
| A1A14                |         |         |         |                   |         |         |         |         |         |         |         |         |         |         |         |         |         |         |    |    |    |    |    |    |    |    |    | X  | X  |    |    |    |    |    |    |    |    |    |    |    |    |    |    |    |    |    |    |    |    |    |    |    |  |  |
| A1A15                |         |         |         |                   |         |         |         |         |         |         |         |         |         |         |         |         |         |         |    |    |    |    |    |    |    |    |    |    |    |    |    |    |    |    |    |    |    |    |    |    |    |    |    |    |    |    |    |    |    |    |    |    |  |  |
| A1A16                |         |         |         |                   |         |         |         |         |         |         |         |         |         |         |         |         |         |         |    |    |    |    |    |    |    |    |    |    |    |    |    |    |    |    |    |    |    |    |    |    |    |    |    |    |    |    |    |    |    |    |    |    |  |  |
| A1A17                |         |         |         |                   |         |         |         |         |         |         |         |         |         |         |         |         |         |         |    |    |    |    |    |    |    |    |    |    |    |    |    |    |    |    |    |    |    |    |    |    |    |    |    |    |    |    |    |    |    |    |    |    |  |  |
| A1A20                |         |         |         |                   |         |         |         |         |         |         |         |         |         |         |         |         |         |         |    |    |    |    |    |    |    |    |    |    |    |    |    |    |    |    |    |    |    |    |    |    |    |    |    |    |    |    |    |    |    |    |    |    |  |  |
| A1A21                |         |         |         |                   |         |         |         |         |         |         |         |         |         |         |         |         |         |         |    |    |    |    |    |    |    |    |    |    |    |    |    |    |    |    |    |    |    |    |    |    |    |    |    |    |    |    |    |    |    |    |    |    |  |  |
| HDA                  |         |         |         |                   |         |         |         |         |         |         |         |         |         |         |         |         |         |         |    |    |    |    |    |    |    |    |    |    |    |    |    |    |    |    |    |    |    |    |    |    |    |    |    |    |    |    |    |    |    |    |    |    |  |  |
| MASSBUS CABLE        |         |         | X       |                   |         |         |         |         |         |         |         |         |         |         |         |         |         |         |    |    |    |    |    |    |    |    |    |    |    |    |    |    |    |    |    |    |    |    |    |    |    |    |    |    |    |    |    |    |    |    |    |    |  |  |
| 3 PHASE DETECTOR PCA |         |         |         |                   |         |         |         |         |         |         |         |         |         |         |         |         |         |         |    |    |    |    |    |    | X  |    |    |    |    |    |    |    |    |    |    |    |    |    |    |    |    |    |    |    |    |    |    |    |    |    |    |    |  |  |





# ERROR CODE GUIDE MATRIX

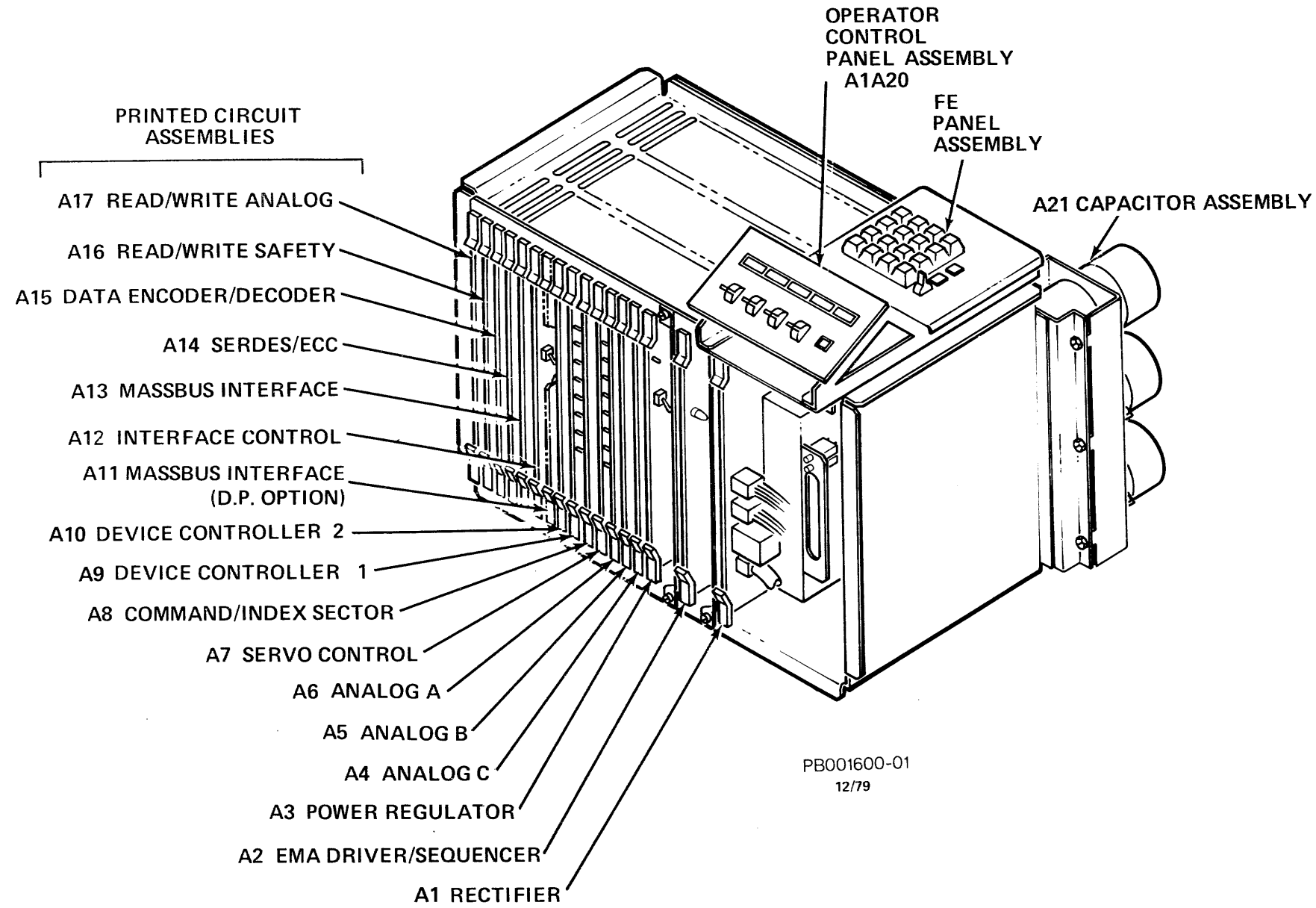

**Power On Start Routine**

You are responding to a reported malfunction. The goal is to successfully identify the failed Field Replaceable Unit (FRU) and to replace that unit with a servicable one. Pathfinder is designed to do that as quickly and accurately as possible. It is essential that the procedures contained in Pathfinder be followed carefully and in the sequence in which they are presented. It is presumed that the field engineer is trained in the operation and maintenance of disk drives in general, and the RP07 in particular.

Efficient investigation of the circumstances existing when the malfunction was detected is important to the earliest completion of troubleshooting and repair. Interview customer personnel to determine what job was being run when the malfunction occurred. Find out if the drive was turned off and on again after the problem was discovered. If online diagnostics were performed, get a list of the tests run and their results. Make note of all customer comments for use during Fault Isolation.

1. Open the front, rear, and top covers.
2. Place the Massbus Enable/Disable switch on A1A12 in the Disable (down) position.
3. Is the DC Safe LED on A1A2 illuminated?

No      Yes → Go to step 8.



4. Insure that the following switches are in the On (up) position:

| <u>Switch</u> | <u>Location</u>        |
|---------------|------------------------|
| CB1           | Power Distribution Box |
| CB3           | Power Distribution Box |
| Service       | A1A3                   |

5. Were any of the above switches in the Off (down) position?

Yes      No → Go to POS 0002.



6. Does CB1 or CB3 constantly trip?

No      Yes → Go to POS 0003.



7. Is the DC Safe LED illuminated now?

Yes      No → Go to POS 0002.



8. The Internal Error Logs are read when steps 9 through 21 are performed. You may skip these steps only when the following two conditions are true:

- You are certain that the FE Control Panel is operating properly, and
- You are certain that the information is not necessary or that it has already been recorded.

9. Record the state of the following indicators and displays:

- The Program Code Display located on the FE Panel.
- The Data Display adjacent to the Program Code Display.
- The A1A7 LEDs visible through the Electronic Gate Matrix (EGM) cover.
- The A1A9 LEDs to the left of A1A7 LEDs.
- The Operator Panel switch positions and light status.

10. If the stack is spinning, place the Start/Stop switch in the Stop position.

11. Place the FE Local/Norm switch in the FE Local position.

12. Did "CE" appear in the Program Code Display?

No      Yes → Go to step 13.



- 12A. Is "0B" present in the Program Code Display?

No      Yes → Go to TST 0003.



- 12B. Is "09" present in the Program Display and "41" present in the Data Display?

Yes      No → Go to TST 0002.



- 12C. Go to TST 2041.

13. Enter the following two digit numbers in the FE Panel keyboard and insure that each number is correctly displayed in the Data Display:

|    |    |    |    |    |    |    |    |
|----|----|----|----|----|----|----|----|
| 00 | 11 | 22 | 33 | 44 | 55 | 66 | 77 |
| 88 | 99 | AA | BB | CC | DD | EE | FF |

14. Were all of the numbers correctly displayed?

Yes      No → Go to TST 0002.



**NOTE**  
The Read Memory utility routine is used to read the error log. The following steps (15 through 23) accomplish this.

15. Enter "FE" in the FE Panel keyboard.

16. Depress the Enter/Step switch.

17. Did "FE" move to the Program Code Display?

Yes      No → Go to TST 0002.



18. Enter "17".

19. Depress the Enter/Step switch.

20. Enter "32".

21. Depress the Enter/Step switch.

**NOTE**  
When you depress the Enter/Step switch, "32" moves from the Data Display into the Program Code Display, and the information in the first memory location of the error log is displayed in the Data Display. To progress through the error log, depress the Enter/Step switch once for each location to be read out. Record the error log location

information from the Program Code Display and the error log data contained in the Data Display. The error log is the scratch pad memory where the drive records a history of malfunctions. A description of each of the error code log memory locations is provided below.

- Seek to long errors

| <u>Memory Location</u> | <u>Number of Errors</u> |
|------------------------|-------------------------|
| 32                     | XX                      |

- Seek overshoot errors

|    |    |
|----|----|
| 33 | XX |
|----|----|

- Soft seek overshoots

|    |    |
|----|----|
| 34 | XX |
|----|----|

- Seek incompletes

|    |    |
|----|----|
| 35 | XX |
|----|----|

- Number of index errors

|    |    |
|----|----|
| 36 | XX |
|----|----|

- Number of PLO unsafes

|    |    |
|----|----|
| 37 | XX |
|----|----|

- The most recent error encountered

| <u>Memory Location</u> | <u>Error Code</u> |
|------------------------|-------------------|
| 38                     | XX                |

- The next 20 locations record error codes that have been encountered and the number of times they occurred.

The format is as follows:

|         |      |
|---------|------|
| 39 & 3A | XXYY |
| through |      |
| 4B & 4C | XXYY |

XX = Error code  
YY = Number of times this error code occurred

- 21A. Depress the reset button on the FE Control Panel.
- 21B. Enter "17" in the FE Panel keyboard.
- 21C. Depress the Enter/Step switch.

21D. Enter "71".

21E. Depress the Enter/Step switch and record the data present in the Data Display. This is the 8080 Microcode revision level.

21F. Depress the Enter/Step switch and record the data present in the Data Display. This is the 2901 Microcode revision level.

22. Remove the Electronic Gate Matrix cover.

23. Make a quick visual inspection of cables and connectors for bad insulation, pulled wires, separated plugs, etc. Any problems found?

No Yes → Repair as required before going to step 24.

24. Inspect the back panel for shorted pins, broken or scraped wired or improperly secured connections. Any problems found?

No Yes → Repair as required before going to step 25.

25. Place the Online switch in the Off (down) position (A1A20).

26. Place the Start/Stop switch in the Stop position (A1A20).

27. Place the Write Protect switch in the On (up) position (A1A20).

28. Place the A-A/B-B switch in the A/B (middle) position (A1A20).

29. Place the FE Local/Norm switch in the norm position (A1A20).

30. Place the Service switch in the Off (down) position (A1A3).

31. Place CB3 in the Off (down) position (front of A2).

32. Place CB2 in the Off (down) position (rear of A1A1).

33. Place CBI in the Off (down) position (front of A2).

34. Place CB2 in the On (up) position.

35. Place CB3 in the On (up) position.

36. Place CBI in the On (up) position.

**NOTE**

The following sequence of events will occur when step 37 is performed:

A. The LEDs on A1A7 will blink in a counting sequence (going from the bottom LED to the top LED).

B. The LEDs on A1A7 and the Program Code and Data Display LEDs on the FE Control Panel will display in succession: all 0s, all 1s, all 2s, etc. to all Fs.

C. The Program Code Display will display the code "01" for about 15 seconds.

D. The Program Code Display will display the code "03".

The entire sequence will take about 30 seconds to complete.

37. Place the Service switch in the On (up) position.

38. Did an "03" appear in the Program Code Display?

No Yes → Go to step 40.

39. Did an "09" appear in the Program Code Display?

No Yes → Observe the Data Display. Note the error code and consult the Error Code Guide Matrix. Then go to the section of Pathfinder that is concerned with the diagnostic routine referenced by the Error Code Guide Matrix by the displayed error code.

39A. Is "0B" present in the Program Code Display?

No Yes → Go to TST 0003.

40. Did all of the events described for step 37 occur properly?

Yes No → Go to TST 0002.

40A. Is "6A" present in the Data Display?

Yes No → No to step 41.

40B. Is the system powered off?

Yes No → A problem exists with the Massbus Recognition circuits or cables. Go to TST 206A.

40C. A powered off system will cause error code "6A". You may continue Pathfinder under this condition by going to step 41. If you prefer, power up the system and go to step 37 to insure that there is not a problem in the Massbus circuits or cables.

41. Place the Start/Stop switch in the Start position.

42. Did the Program Code Display go to "04"?

Yes No → Go to TST 0002.

Continue.

**NOTE**

The rest of the diagnostic routines are now running. The Program Code Display will present the following program codes in the sequence shown.

- 03 - About 10 seconds
- 04 - Momentarily
- 05 - About 15 seconds
- 08 - About 20 seconds
- 06 - On Track Monitor
- 09 - Hold - displayed when hard error is encountered.
- 0A - Hold - displayed when the Start/Stop switch is placed in the Stop position after a full power up has been completed.

Disregard flashing numbers in the Data Display during this sequence. If a malfunction occurs during this sequence, the drive will halt operations and display "06" or "09" in the Program Code Display and an error code in the Data Display. If "06" appears in the program code display and "00" appears in the data display, no error was encountered.

43. Did "04" remain in the Program Code Display?

No Yes → Go to TST 0001.

44. Did an "09" appear in the Program Code Display?

No Yes → Observe the Data Display. Note the error code and consult the Error Code Guide Matrix. Then go to the section of Pathfinder that is concerned with the diagnostic routine referenced by the Error Code Guide Matrix by the displayed error code.

45. Did an "06" appear in the Program Code Display?

Yes No → Go to TST 0002.

46. Is anything other than '00' present in the data display?

No Yes → Observe the data display. Note the error code and consult the error code guide matrix. Then go to the section of Pathfinder that is concerned with the diagnostic routine referenced in the error code guide matrix by the displayed error code.

47. Are you trying to isolate a functional read/write problem?

No Yes → Perform DIA 001B, and then perform DIA 001E.

48. Are you trying to isolate a servo guard band problem?

No Yes → Go to TST 2051.

49. Are you trying to isolate any other functional servo problem?

No Yes → Go to TST 2050.

50. Place the FE Local/Norm switch to the Local position. Wait for "CE" to appear in the Program Code Display.

51. Enter "FE" in the FE Panel keyboard.

52. Depress the Enter/Step switch.

53. Enter "15" in the FE Panel keyboard.

54. Depress the Enter/Step switch.

55. Record the position of the switches on the Operator's Control Panel.

56. Place each of the switches in the following positions and note the state of the indicated light:

| <u>Switch</u> | <u>Switch Position</u> | <u>Light State</u>    |
|---------------|------------------------|-----------------------|
| Start/Stop    | Stop                   | Unsafe Off            |
|               | Start                  | Unsafe on or blinking |
| Online        | Down                   | Online Off            |
|               | Up                     | Online on or blinking |
| Write Protect | Down                   | Write Protect Off     |
|               | Up                     | Write Protect On      |
| Access A/B    | "A"                    | "A" On                |
|               | "A/B"                  | "A" and "B" On        |
|               | "B"                    | "B" On                |

57. Does the Operator's Panel operate as described?

Yes      No → Place Service switch down (Off).  
 ↓ Place CB3 down (Off). Remove and  
 ↓ replace the Operator Control Panel.  
 ↓ Place FE Local/Norm switch to  
 ↓ Norm. Place CB3 up (On). Place the  
 ↓ Service switch up (On). Perform step  
 ↓ 58. Wait for "06" to appear in the  
 ↓ Program Code Display. If it does not  
 ↓ appear, go to Level III, INF3005. If it  
 ↓ does appear, perform steps 50-52 and  
 ↓ then go to step 60.

58. Return the switches to the positions recorded in step 55.
59. Depress the reset switch until "FE" appears in the Program Code Display.
60. Perform steps 18 through 21 of this procedure.
61. Were there any errors logged?
- Yes      No → Go to step 63.  
 ↓
62. Note the error code in position 38 of the error log. Using that error code, consult the Error Code Guide Matrix and then go to the section of Pathfinder that is concerned with the diagnostic routine referenced in the Error Code Guide Matrix.
63. Depress the reset switch.

64. Place the Start/Stop switch in the Stop position.
65. Place the FE Local/Norm switch in the Norm position.
66. Place the Start/Stop switch in the Start position.
67. Place the Online switch in the Online position. Wait for the Online indicator to illuminate.
68. Place the Massbus Enable/Disable switch on A1A12 in the Enable (up) position.
69. Perform subsystem verification tests.
70. Are there error indications presented?

No      Yes → Use conventional system trouble-  
 ↓ shooting procedures.

71. Return the drive to customer control.



**Power Supply Test**

You have arrived at this routine from POS 0001, step 5 or 7 because the DC Safe LED is not illuminated.

The purpose of this routine is to isolate a suspected power supply failure.

**CAUTION**

CB1 must be off when removing or installing A1A1, A1A2 or A1A3. Voltage is present and can cause damage to equipment.

1. Is CB3 in the tripped (down) position?

No Yes → Go to POS 0003.



2. Is CB1 in the tripped (down) position?

No Yes → Go to POS 0003.



3. Remove the Electronic Gate Matrix cover.
4. Place the Service switch in the Off (down) position and then place CB1 in the Off (down) position.
5. Unseat the following PCAs:
  - A1A4 A1A11
  - A1A5 A1A12
  - A1A6 A1A13
  - A1A7 A1A14
  - A1A8 A1A15
  - A1A9 A1A16
  - A1A10 A1A17
6. Unplug the following assemblies:
  - HDA
  - Operator's Panel
- 6A. Place CB1 in the On (up) position.
7. Place the Service switch in the On (up) position.

8. Is the DC Safe LED on A1A2 illuminated?

No Yes → Go to TST 0000.



9. Place the Service switch in the Off (down) position.
10. Place CB1 in the down (Off) position.
11. Unseat A1A2 and A1A3 and place CB1 to the On (up) position.
- 11A. Set the oscilloscope controls to the following settings:

Volts/cm: 0.5V (X10 probe)  
 Time/cm: 1 msec  
 Trigger Mode: Automatic  
 Trigger Source: Normal

12. Connect an insulated female jumper between oscilloscope ground and J010025 (ground). Also connect an insulated female scope probe from oscilloscope channel one to the following pins in succession:

| Pin     | Signal       | Tolerance |
|---------|--------------|-----------|
| J010007 | -11V (Unreg) | +3.0V     |
| J010101 | +11V (Unreg) | +3.0V     |
| J010015 | +22V (Unreg) | +3.0V     |
| J010021 | -22V (Unreg) | +3.0V     |

13. Are any of the voltages specified in step 12 within tolerance?

Yes No → Go to step 39.



14. Are +11V (Unreg) within tolerance with no ripple present?

Yes No → Go to step 16.



15. Are +22V (Unreg) within tolerance with no ripple present?

Yes No → Go to step 17.



- 15A. Go to step 62.

16. Place CB1 in the Off (down) position.

- 16A. Unplug P1 and P3 from A1A1.

**NOTE**

There are three plugs plugged into the bottom front of A1A1. P1 is the top plug, and P3 is the bottom plug.

- 16B. Place CB1 in the On (up) position.

- 16C. Measure A1A1P1001 with respect to A1A1P3002 using a VOM set on an AC scale of no less than 15V.

**NOTE**

The diagram below shows the pin numbering for both plugs.

**Top of Drive**

|                |   |   |   |
|----------------|---|---|---|
| Front of Drive | 9 | 6 | 3 |
|                | 8 | 5 | 2 |
|                | 7 | 4 | 1 |

**NOTE**

P1 has 9 pins while P2 and P3 have only 6 pins.

- 16D. Is the voltage measured in step 16C 11.0 ±3.0 VAC?

Yes No → Place CB1 in the Off (down) position. Remove and replace the transformer assembly insuring that P1 through P3 are plugged back into A1A1. Go to step 63.



- 16E. Measure A1A1P1004 with respect to A1A1P3003 using a VOM set on an AC scale of no less than 15V.

- 16F. Is the voltage measured in step 16E 11.0 ±3.0 VAC?

Yes No → Place CB1 in the Off (down) position. Remove and replace the transformer assembly insuring that P1 through P3 is plugged back into A1A1. Go to step 63.



- 16G. Place CB1 in the Off (down) position.

- 16H. Plug P1 and P3 back into A1A1.

- 16I. Unplug the capacitor assembly from the rear of A1A1.

**CAUTION**

The capacitors on the capacitor assembly may still be charged. Use a meter lead to short across the pins listed in step 16J before making the measurements.

16J. Use an ohmmeter to check the following pins on J1 of the capacitor assembly. Allow a few seconds for the capacitors to charge when taking each reading. The diagram below shows the pin locations on J1.

**Top**

|    |    |    |
|----|----|----|
| 3  | 2  | 1  |
| 6  | 5  | 4  |
| 9  | 8  | 7  |
| 12 | 11 | 10 |

| Pin | to | Pin | Component  |
|-----|----|-----|--|
| 4   |    | 7   | Elect. capacitor                                 |
| 6   |    | 7   | Elect. capacitor                                 |
| 10  |    | 11  | Elect. capacitor                                 |
| 1   |    | 8   | 10 ohm resistor and elect. capacitor in parallel |
| 2   |    | 8   | 10 ohm resistor and elect. capacitor in parallel |

16K. Are there any shorts or opens in the capacitor assembly?

No → Yes → Remove and replace the capacitor assembly. Go to step 63.

16L. Remove and replace A1A1. Insure that CB4 and CB5 on A1A1 are reset (in).

16M. Plug the capacitor assembly back into A1A1.

16N. Go to step 62.

17. Is CB4 or CB5 on A1A1 in the tripped (out) position?

Yes → No → Go to step 17D.

17A. Reset CB4 and/or CB5 as required.

17B. Check +22V (J010015 to gnd) and -22V (J010021 to gnd).

17C. Are  $\pm 22V$  within tolerance ( $\pm 3.0V$ )?

NO → Yes → Place CBI down (Off) and go to step 18.

17D. Place CBI in the Off (down) position.

17E. Unplug P1 from A1A1.

**NOTE**

There are three plugs plugged into the bottom front of A1A1. P1 is the top plug, and P3 is the bottom plug.

17F. Place CBI in the On (up) position.

17G. Measure A1A1P1003 with respect to A1A1P1009 using a VOM set on an AC scale of no less than 25V.

**NOTE**

The diagram below shows the pin location for P1.

**Top of Drive**

|   |   |   |
|---|---|---|
| 9 | 6 | 3 |
| 8 | 5 | 2 |
| 7 | 4 | 1 |

Front of Drive

**NOTE**

P1 has 9 pins while P2 and P3 have only 6 pins.

17H. Is the voltage measured in step 17G  $22\pm 3.0$  VAC?

Yes → No → Place CBI in the Off (down) position. Remove and replace the input transformer assembly insuring that P1 through P3 are plugged back into A1A1. Go to step 63.

17I. Measure A1A1P1006 with respect to A1A1P1009 using a VOM set to an AC scale of not less than 25 volts.

17J. Is the voltage measured in step 17I  $22\pm 3.0$  VAC?

Yes → No → Place CBI in the Off (down) position. Remove and replace the input transformer assembly insuring that P1 through P3 are plugged back into A1A1. Go to step 63.

17K. Perform steps 16G through 16J of this procedure, and then go to step 17L.

17L. Are there any shorts or opens in the capacitor assembly?

No → Yes → Remove and replace the capacitor assembly. Go to step 63.

17M. Remove and replace A1A1.

17N. Plug the capacitor assembly back into A1A1.

18. Reseat A1A3.

19. Place CBI in the On (up) position.

20. Is CB4 or CB5 on A1A1 in the tripped (out) position?

Yes → No → Go to step 31.

20A. Place CBI in the Off (down) position.

21. Reset CB4 and CB5.

21A. Place CBI in the On (up) position.

22. Did CB4 or CB5 trip again?

Yes → No → Go to step 27.

23. Place CBI in the Off (down) position and reset CB4 and CB5.

24. Remove and replace A1A3.

25. Place CBI in the On (up) position.

26. Did CB4 or CB5 trip again?
- No      Yes → Go to Pathfinder Level III, INF 3002.
- ↓
27. Place CB1 in the Off (down) position.
28. Unseat A1A3.
29. Place CB1 in the On (up) position.
30. Go to step 61.
31. Place CB1 in the Off (down) position.
32. Plug in the Operator's Panel back into the backplane at J7 (pins 41 through 80).
33. Place CB1 in the On (up) position.
34. Did CB4 or CB5 on A1A1 move to the tripped (out) position?
- Yes      No → Go to step 37.
- ↓
35. Place CB1 in the Off (down) position.
36. Remove and replace the Operator's Panel.
37. Unplug the Operator's Panel.
38. Go to step 28.
39. Use a VOM on an AC scale of no less than 250V to measure the power transformer AC input at the terminal strip on top of the transformer. You are looking for approximately 200-240 VAC.
40. Is the AC input voltage present?
- Yes      No → Go to step 47.
- ↓
41. Place CB1 in the Off (down) position.

**CAUTION**

Capacitor C1 must be discharged before proceeding to step 42. This can be accomplished by using a screwdriver or other conductive object to short across the C1 terminals.

42. Remove one red transformer lead from C1 (located to the right of the input transformer).
43. Measure C1 with an ohmmeter. Is it shorted or leaky?
- No      Yes → Remove and replace C1. Place CB1 in the On (up) position and go to step 60.
- ↓
44. Replace the power transformer.
45. Place CB1 in the On (up) position.
46. Go to step 60.
47. Check AC input voltage at the wall. Is it OK?
- Yes      No → Repair and go to step 60.
- ↓
48. Place CB1 in the Off (down) position.

**CAUTION**

If any other drives receive their AC input power through this drive (a cable connected to J2), all succeeding drives in the AC power daisy chain must be powered off before proceeding to step 49.

49. Unplug P1 through P5 from the Power Distribution Box.
- 49A. Check the AC input voltage at the cable end just removed from J1. Use the VOM on a scale of at least 250 VAC, and measure the voltage at the cable from Pin 2 to Pin 5. Does the VOM indicate approximately 200 to 240 VAC?
- Yes      No → Trip the AC circuit breaker at the wall, and repair or replace the AC input cable assy as required. Restore AC power at the wall and go to step 58.
- ↓

50. Remove the Power Distribution Box from the disk drive and remove the side access cover.
51. Check for continuity between the line and the load terminals of the line filter. Is the filter OK?
- Yes      No → Remove and replace the line filter and go to step 56.
- ↓
52. Place CB1 in the On (up) position and check for continuity between the following terminals:

- 1 and 4
- 2 and 5
- 3 and 6

The diagram below shows the pin locations on CB1.

**Top of Distribution Assy**

|   |   |   |
|---|---|---|
| 1 | 2 | 3 |
| 4 | 5 | 6 |

- 52A. Is CB1 OK?
- Yes      No → Remove and replace CB1 and go to step 56.
- ↓
53. Return CB1 to the Off (down) position.
54. Check for continuity between the A and B terminals of both sides of CB3 (be sure that CB3 is in the On (up) position).
- 54A. Is CB3 OK?
- Yes      No → Remove and replace CB3 and go to step 56.
- ↓
55. Remove and replace the input transformer.
56. Reinstall the side access cover onto the Power Distribution Box.
57. Reinstall the Power Distribution Box into the Disk drive.

58. Plug P1 through P5 back into the Power Distribution Box (succeeding Disk Drives in the AC input power daisy chain may now be powered up).
59. Place CBI in the On (up) position.
- 59A. Place CB3 in the On (up) position.
60. Check the input voltages to the transformer. Are they OK?
  - Yes    No → Go to Pathfinder Level III, INF 3002.
61. Repeat step 12 of this procedure. Are all of the voltages referred to in step 12 within the tolerances specified.
  - Yes    No → Go to Pathfinder Level III, INF 3002.
62. Place CBI in the Off (down) position.
63. Reseat A1A3.
64. Place CBI in the On (up) position.
65. Place the Service switch in the up (On) position.
66. Use a VOM on the appropriate DC scale to check the voltages indicated below.

| <u>Pin</u> | <u>Signal</u> | <u>Tolerance</u> |
|------------|---------------|------------------|
| J030005    | +22V          | +3.0V            |
| J030035    | +12V          | +0.7V            |
| J030123    | +15V          | +0.9V            |
| J030125    | -15V          | +0.9V            |
| J030156    | +5V           | +2.5/-0.3V       |
| J030109    | -4V           | +0.2V            |
| J030039    | +5V           | +0.3V            |
| J030033    | GND           | -----            |

**NOTE**  
-5V will be missing because A1A2 is not seated.

**CAUTION**

CBI must be Off when removing or installing A1A1, A1A2 or A1A3. Voltage is present and can cause damage to the equipment.

67. Are all the voltages within tolerance?
  - Yes    No → Place the Service switch in the Off (down) position and then place CBI in the Off (down) position. Remove and replace A1A3. Go to step 68.
- 67A. Go to step 71.
68. Place CBI in the On (up) position.
69. Place the Service switch in the On (up) position.
70. Check the voltages listed in step 66. Are they within tolerances?
  - Yes    No → Go to Pathfinder Level III, INF 3002.
71. Place the Service switch in the Off (down) position.
72. Place CBI in the Off (down) position.
73. Reseat A1A2.
74. Place CBI in the On (up) position.
75. Place the Service switch in the On (up) position.
76. Is the DC Safe LED on A1A2 illuminated?
  - No    Yes → Go to step 87.
77. Measure J030037 for -5V.
78. Is -5V within tolerance (+0.5V)?
  - No    Yes → Go to step 81.
79. Measure J020028 for approximately zero volts (logic low).

80. Is J020028 at a logic low (0V)?
  - No    Yes → Place the Service switch in the Off (down) position and then place CBI in the Off (down) position. Remove and replace A1A3. Go to step 84.
81. Place the Service switch in the down (Off) position.
82. Place CBI in the down (Off) position.
83. Remove and replace A1A2.
84. Place CBI in the up (On) position.
85. Place the Service switch in the up (On) position.
86. Is the DC Safe LED illuminated?
  - Yes    No → Go to Pathfinder Level III, INF 3002.
87. Place the Service switch in the down (Off) position and CBI in the down (Off) position.
88. Reseat the following PCAs:
 

|       |       |
|-------|-------|
| A1A4  | A1A11 |
| A1A5  | A1A12 |
| A1A6  | A1A13 |
| A1A7  | A1A14 |
| A1A8  | A1A15 |
| A1A9  | A1A16 |
| A1A10 | A1A17 |
89. Plug the HDA back into J17 and the Operator's Panel back into J7 (pins 41 through 80).
90. Place CBI in the On (up) position and then place the Service switch in the On (up) position.
91. Is the DC Safe LED illuminated?
  - No    Yes → Go to step 98.
92. Place CBI in the down (Off) position.
93. Unseat the PCAs listed in step 88.
94. Unplug the Operator's Panel and the HDA.

95. Place CBI in the On (up) position.

96. Is the DC Safe LED illuminated?

No      Yes → Go to TST 0000.



97. Go to Pathfinder Level III, INF 3002.

98. Use a VOM on the appropriate DC scale to test for the voltages on the pins indicated below:

| <u>Pin</u> | <u>Signal</u> | <u>Tolerance</u> |
|------------|---------------|------------------|
| J030005    | +22V          | +3.0V            |
| J030035    | +12V          | +0.7V            |
| J030123    | +15V          | +0.9V            |
| J030125    | -15V          | +0.9V            |
| J030156    | +5V           | +2.5/-0.3V       |
| J030109    | -4V           | +0.2V            |
| J030037    | -5V           | +0.3V            |
| J030039    | +5V           | +0.3V            |
| J030033    | GND           | -----            |

99. Are all the voltages within tolerance?

Yes      No → Go to Pathfinder Level III, INF 3002.



100. Go to POS 0001, step 23.

THIS PAGE INTENTIONALLY LEFT BLANK

**CB1 and CB3 Overload Routine**

You have arrived at this procedure from POS 0002, step 1 or 2, or POS 0001, step 6 because CB1 or CB3 is tripping.

The purpose of this procedure is to isolate a failure that is causing an over-current condition.

1. Place CB1, CB2 and CB3 in the Off (down) position.
2. Place CB2 and CB3 in the On (up) position and reset CB4 and CB5 on A1A1 if necessary.
3. Place CB1 in the On (up) position.

**NOTE**

If CB3 trips, CB1 may also trip. If this occurs, reset CB1 and continue with the procedure.

4. Does CB3 trip immediately?

No      Yes → Go to step 39.

5. Does CB1 trip?

No      Yes → Go to step 17.

6. Does CB3 trip after a warm up period?

Yes      No → Go to POS 0001, step 22.

- 6A. Wait for a few minutes for the drive to cool down. Perform step 7 immediately after returning CB3 to the On (up) position again.

7. Place the palm of the hand over the top of the Electronic Gate Matrix.

8. Is the air flow through the Gate adequate?

Yes      No → Go to step 13.

9. Remove and replace A1A2.

10. Place CB3 in the On (up) position.

11. Does CB3 trip after a warm up period?

No      Yes → Go to Pathfinder Level III, INF 3002.

12. Go to POS 0001, step 22.

13. Place CB1 in the Off (down) position.

14. Check the Prefilter. Is it blocked or clogged?

No      Yes → Remove and replace the Prefilter as required. Place CB1 in the On (up) position and go to step 10.

15. Remove and replace the Blower Assembly.

16. Place CB1 in the On (up) position and go to step 10.

17. Does CB1 trip when the stack motor starts to spin?

Yes      No → Go to step 22.

18. Remove and replace the Motor/Brake Assembly.

19. Place CB1 in the On (up) position.

20. Did CB1 move to the tripped (down) position?

No      Yes → Go to Pathfinder Level III, INF 3002.

21. Go to POS 0001, step 22.

22. Unplug P3 or P3A (whichever is used) from the Power Distribution Box.

23. Place CB1 in the On (up) position.

24. Did CB1 move to the tripped (down) position?

Yes      No → Place CB1 in the Off (down) position. Remove and replace the Blower Assembly. Plug P3 or P3A back into the Power Distribution Box and go to step 19.

25. Plug P3 or P3A back into the Power Distribution Box.

**CAUTION**

If any other drives receive their AC input power through this drive (a cable connected to J2 on the Power Distribution Box), all succeeding drives in the AC power daisy chain must be powered off before proceeding to step 26.

26. Unplug P1 through P5 from the Power Distribution Box.

27. Remove the Power Distribution Box from the drive.

28. Is CB1 mechanically bad--does it trip by itself without power applied?

Yes      No → Go to step 33.

29. Remove the side access cover from the power distribution box and remove and replace CB1.

30. Reinstall the side cover onto the Power Distribution Box, and reinstall the Power Distribution Box into the drive.

31. Plug P1 through P5 back into the Power Distribution Box (succeeding disk drives in the AC input power daisy chain may now be powered up).

32. Go to step 19.

33. Remove the side access cover from the Power Distribution Box. Unplug P6 and P7 from the three-phase sensor PCA.

**NOTE**

K1 is the relay located on the inside back of the Power Distribution Box. It has four large copper terminals and two small terminals located on it.

34. Use an ohmmeter to check K1 for a short between the coil terminals (the coil terminals are the two small non-copper terminals at the bottom of the relay).

35. Is K1 shorted?

No →  
Yes → Remove and replace K1. Plug P6 and P7 back into the three-phase sensor PCA and go to step 30.

36. Using an ohmmeter, check the Power Distribution Box for internal shorts by making the following measurements at the rear of FL1:

| <u>From Terminal</u> | <u>To Terminal</u> |
|----------------------|--------------------|
| Phase A              | Ground             |
| Phase B              | Ground             |
| Phase C              | Ground             |
| Neutral              | Ground             |

37. Does the Power Distribution Box contain an internal short?

No →  
Yes → Repair as required. Plug P6 and P7 back into the three-phase sensor PCA and go to step 30.

38. Replace the three-phase sensor PCA with a new one. Plug P6 and P7 back into the three-phase sensor PCA and go to step 30.

39. Unseat A1A4 through A1A17.

40. Unplug the Operator's Panel and the HDA.

41. Place CB3 in the On (up) position.

42. Did CB3 trip again?

No →  
Yes → Go to step 57.

43. Place the Service switch in the Off (down) position. Reseat one PCA at a time placing the Service switch in the On (up) position to see if CB3 trips, placing it in the Off (down) position to reseat the next PCA. When CB3 trips, remove and replace the last PCA reseated and reseat the remaining PCAs.

44. Place the Service switch in the on (up) position.

45. Did you find a bad PCA in step 43?

Yes →  
No → Go to step 48.

46. Place CB3 in the On (up) position.

47. Did CB3 trip again?

No →  
Yes → Go to Pathfinder Level III, INF 3002.

48. Place CB3 in the Off (down) position.

49. Plug the Operator's Panel back into the backplane at J7 (pins 41 through 80).

50. Place CB3 in the On (up) position.

51. Did CB3 move to the tripped (down) position?

No →  
Yes → Remove and replace the Operator's Panel. Place CB3 in the On (up) position. If CB3 trips again, go to Pathfinder Level III, INF 3002, else go to step 52.

52. Place CB3 in the Off (down) position.

53. Plug in the HDA.

54. Place CB3 in the On (up) position.

55. Did CB3 move to the tripped (down) position?

No →  
Yes → Remove and replace the HDA. Place CB3 in the On (up) position. If CB3 trips again, go to Pathfinder Level III, INF 3002, else go to step 56.

56. Go to POS 0001, step 22.

57. Unseat A1A2.

58. Place CB3 in the On (up) position.

59. Did CB3 trip again?

No →  
Yes → Go to step 84.

60. Use a VOM to measure the DC voltages listed below:

| <u>Pin</u> | <u>Voltage</u> | <u>Tolerance</u> |
|------------|----------------|------------------|
| J030005    | +22V           | +3.0V            |
| J030123    | +15V           | +0.9V            |
| J030035    | +12V           | +0.9V            |
| J030033    | GND            | -----            |

61. Are all of the voltages checked in step 60 within tolerance?

Yes →  
No → Go to step 73.

62. Go to step 64.

64. Place CB3 in the Off (down) position.

65. Remove and replace A1A2.

66. Place CB3 in the On (up) position.

67. Did CB3 trip again?

No →  
Yes → Go to Pathfinder Level III, INF 3002.

68. Place CB3 in the Off (down) position.

69. Reseat A1A04 through A1A17.

70. Plug the HDA back into J17 and the Operator's Panel back into J7 (pins 41 through 80).

71. Place CB3 in the on (up) position.

72. Go to POS 0001, step 23.

73. Place CB3 in the Off (down) position.

74. Unseat A1A3.

75. Place CB3 in the On (up) position.

76. Check for the appropriate voltages as indicated below with respect to Pin J010025 (ground).



| <u>Pin</u> | <u>Voltage</u> | <u>Tolerance</u> |
|------------|----------------|------------------|
| J010007    | -11V (Unreg)   | +3.0V            |
| J010101    | +11V (Unreg)   | +3.0V            |
| J010015    | +22V (Unreg)   | +3.0V            |
| J010021    | -22V (Unreg)   | +3.0V            |

77. Are all the voltages checked in step 76 within tolerance?

No Yes → Place CB3 in the Off (down) position. Remove and replace A1A3. Reseat A1A2 and go to step 66.

78. Check the appropriate AC voltages as indicated below. Use a voltmeter.

**A1A1**

| <u>From</u> | <u>To</u> | <u>Voltage</u> | <u>Tolerance</u> |
|-------------|-----------|----------------|------------------|
| P1003       | P1009     | 22VAC          | +3.0V            |
| P1006       | P1009     | 22VAC          | +3.0V            |
| P1001       | P3005     | 11VAC          | +3.0V            |
| P1004       | P3006     | 11VAC          | +3.0V            |

**NOTE**

There are three plugs plugged into the bottom front of A1A1. P1 is the top plug, and P3 is the bottom plug. The diagram below shows the pin locations for both plugs.

**Top of Drive**

|                |   |   |   |
|----------------|---|---|---|
| Front of Drive | 9 | 6 | 3 |
|                | 8 | 5 | 2 |
|                | 7 | 4 | 1 |

**NOTE**

P1 has 9 pins while P2 and P3 have only 6 pins.

79. Are all of the voltages checked in step 78 within tolerance?

No Yes → Place CB3 in the Off (down) position. Remove and replace A1A1. Reseat A1A2 and A1A3 and go to step 66.

80. Place CB3 in the Off (down) position.

81. Remove and replace the AC input transformer.

82. Reseat A1A2 and A1A3.

83. Go to step 66.

84. Unseat A1A3.

85. Place CB3 in the On (up) position.

86. Did CB3 trip again?

Yes No → Place CB3 in the Off (down) position. Remove and replace A1A3. Reseat A1A2 and go to step 66.

87. Unplug A1A1P1, A1A1P2, A1A1P3.

**CAUTION**

When performing step 88, return CB3 to the Off (down) position immediately if it does not trip. Damage to the equipment may result if CB3 is left on while A1A1P1 is unplugged.

88. Place CB3 in the On (up) position only momentarily, then (if it does not trip) return it to the Off (down) position.

89. Did CB3 trip?

No Yes → Go to step 99.

90. Place CB3 in the Off (down) position.

91. Unplug the capacitor assembly from the rear of A1A1.

**CAUTION**

The capacitors on the capacitor assembly may still be charged. Use a meter lead to short across the pins listed in step 92 before making the measurements.

92. Use an ohmmeter to check the following pins on J1 of the capacitor assembly. Allow a few seconds for the capacitors to charge when taking readings. The diagram below shows the pin location on J1.

**Top**

|    |    |    |
|----|----|----|
| 3  | 2  | 1  |
| 6  | 5  | 4  |
| 9  | 8  | 7  |
| 12 | 11 | 10 |

Pin to Pin Component

|    |    |  |
|----|----|--|
| 4  | 7  | Elect. capacitor                                 |
| 6  | 7  | Elect. capacitor                                 |
| 10 | 11 | Elect. capacitor                                 |
| 8  | 2  | 10 ohm resistor and elect. capacitor in parallel |
| 8  | 1  | 10 ohm resistor and elect. capacitor in parallel |

93. Are there any shorts or opens in the capacitor assembly?

No Yes → Remove and replace the capacitor assembly. Go to step 96.

94. Remove and replace A1A1.

95. Plug the capacitor assembly back into A1A1.

96. Plug A1A1P1, A1A1P2, and A1A1P3 back in.

97. Reseat A1A2 and A1A3.

98. Place CB1 in the On (up) position and go to step 66.

99. Unplug P5 from the power distribution box.

100. Place CB3 in the On (up) position only momentarily; then return it to the Off (down) position.

101. Did CB3 trip again?

Yes No → go to step 110.

**CAUTION**

If any other disk drives receive their AC input power through this drive (a cable connected to J2 on the power distribution box), all succeeding drives in the AC power daisy chain must be powered off before proceeding to step 102.

- 102. Place CBI in the Off (down) position and unplug P1 through P4 from the power distribution box.
- 103. Remove the power distribution box from the drive.
- 104. Using an ohmmeter, check the power distribution box for internal shorts by making the following measurements at the rear of FL1:

| <u>From Terminal</u> | <u>To Terminal</u> |
|----------------------|--------------------|
| Phase A              | Ground             |
| Phase B              | Ground             |
| Phase C              | Ground             |
| Neutral              | Ground             |

- 115. Place CBI in the On (up) position.
- 116. Go to step 96.

- 105. Does the Power Distribution Box contain an internal short?

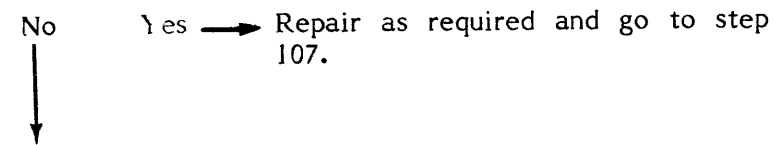

- 106. Remove and replace CB3.
- 107. Reinstall the power distribution box into the drive.
- 108. Plug P1 through P5 back into the power distribution box.
- 109. Place CBI in the On (up) position and go to step 96.
- 110. Place CBI in the Off (down) position.

**NOTE**

Capacitor C1 must be discharged before proceeding to step 111. This can be accomplished by using a screwdriver or other conductive object to short across the C1 terminals.

- 111. Remove one red transformer lead from C1 (located to the right of the input transformer).

- 112. Measure C1 with an ohmmeter. Is it shorted or leaky?

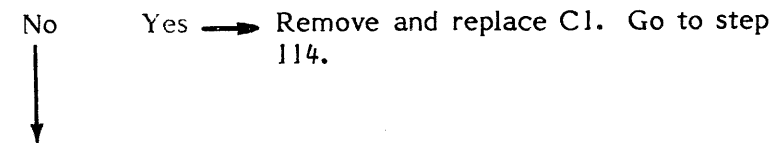

- 113. Remove and replace the input transformer.
- 114. Plug P5 back into the power distribution box.

DIA 0001

PATHFINDER LEVEL I

DIA 0001

You have arrived at this procedure from the error code guide matrix.

- 1. Place the start/stop switch in the stop position. If the stack is spinning, wait for it to stop.
- 1A. Place the service switch in the Off (down) position.

NOTE

The following sequence of events will occur when step 2 is performed:

- A. The LEDs on A1A7 will blink in a counting sequence.
- B. The LEDs on A1A7 and the Program Code and Data Displays on the FE Control Panel will display in succession: all 0s, all 1s, all 2s, etc. to all Fs.
- C. The Program Code '01' will be displayed for approximately 15 sec.
- D. The Program Code '03' will be displayed for approximately 10 sec.
- E. Program Code '05' will be displayed for approximately 15 sec.
- F. Program Code '08' will be displayed for approximately 10 sec.
- G. Program Code '06' will be displayed to indicate 'on track monitor'.

Disregard flashing numbers in the data display during this sequence. If a malfunction occurs, the drive will halt operations and display '09' in the program code display and an error code in the data display.

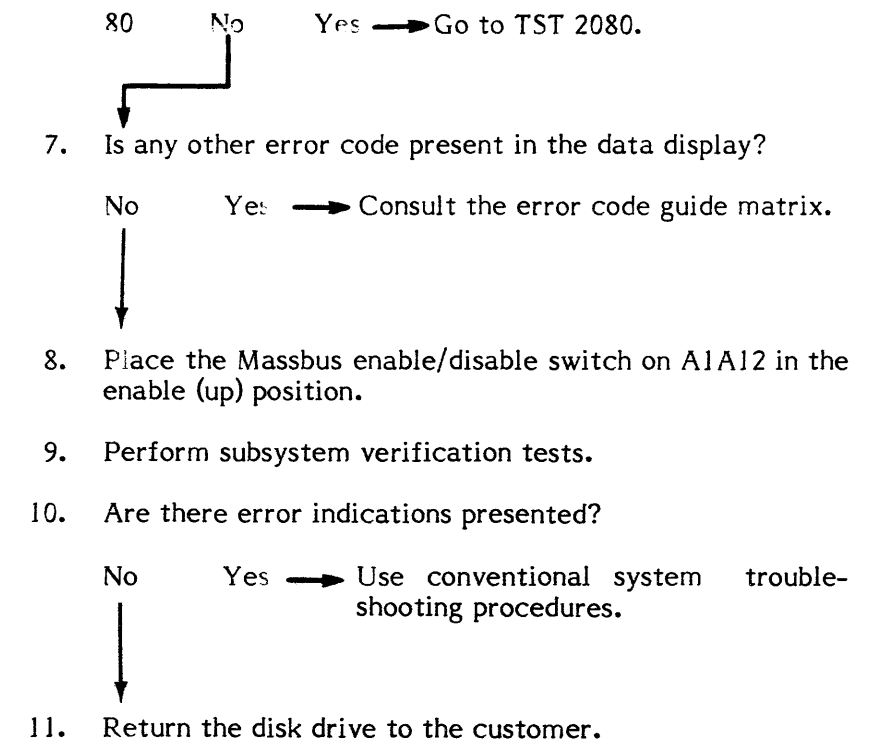
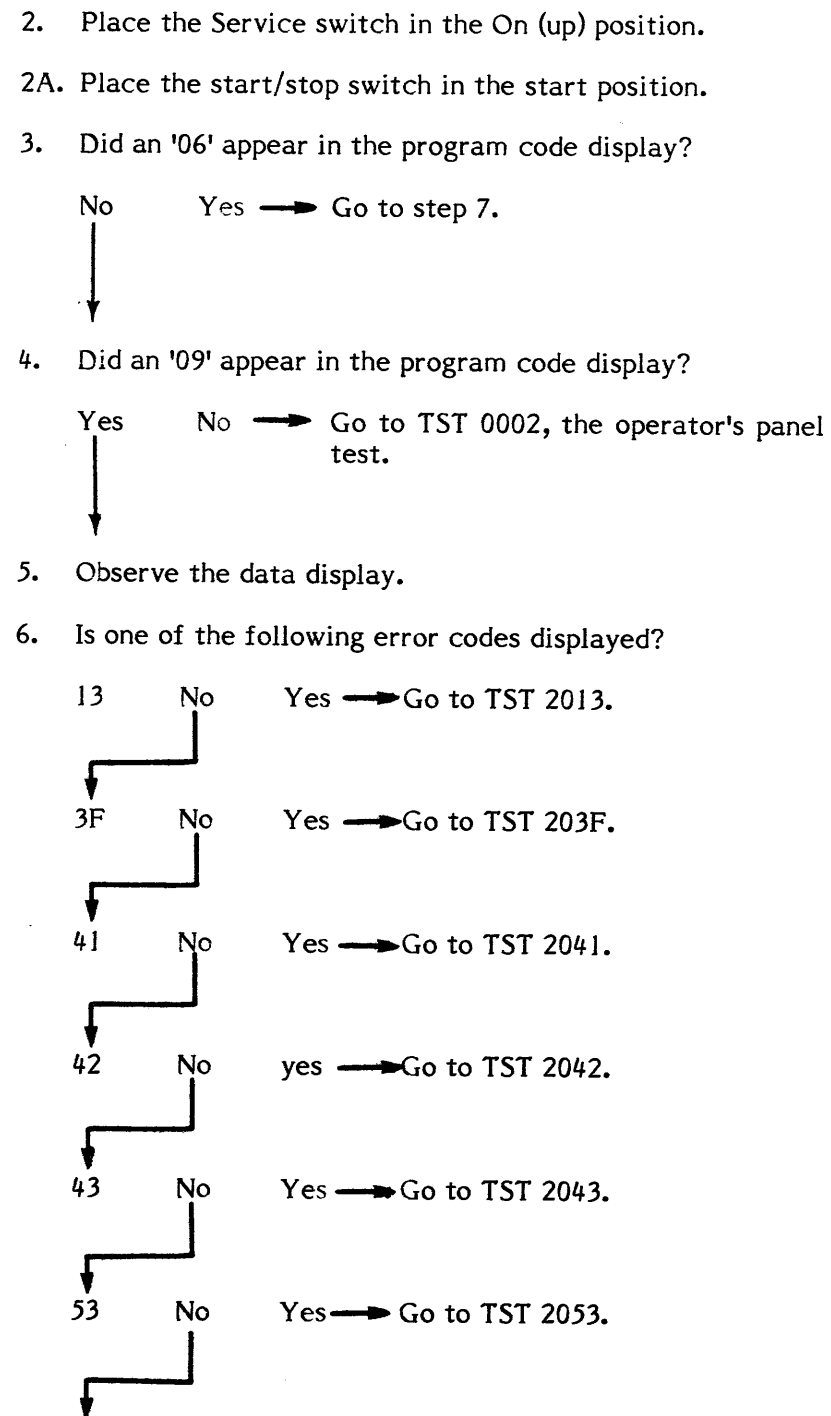

**DIA 0002                      PATHFINDER LEVEL I                      DIA 0002**

You have arrived at this procedure from the error code guide matrix.

You are testing the RPDC register.

1. Place the start/stop switch in the stop position and wait for the stack to stop spinning.
2. Place the FE local/norm switch in the FE local position.
3. Wait for 'CE' to appear in the program code display.
4. Enter 'FE' in the FE panel keyboard.
5. Depress the enter/step switch.
6. Enter '39'.
7. Depress the enter/step switch.
8. Enter '11'.
9. Depress the enter/step switch.
10. Is one of the following error codes present in the data display?  

|    |    |                       |
|----|----|-----------------------|
| DA | No | Yes → Go to TST 20DA. |
|    |    |                       |
| DC | No | Yes → Go to TST 20DC. |
|    |    |                       |
11. Is any other error code present in the data display?  

|    |  |
|----|--|
| No | Yes → Consult the error code guide matrix. |
|    |  |
12. Depress the reset button.
13. Enter '1E'.
14. Depress the enter/step switch.
15. Enter '11'.

16. Depress the enter/step switch.
17. Is error code 'ED' present in the data display?  

|    |   |
|----|---|
| No | Yes → Go to Pathfinder Level III, INF 3087. |
|    |   |
18. Is any other error code present in the data display?  

|    |  |
|----|--|
| No | Yes → Consult the error code guide matrix. |
|    |  |
19. Place the FE local/norm switch in the norm position.
20. Place the start/stop switch in the start position.
21. Allow the drive to cycle up or go to state '09'. Is there an error code present in the data display?  

|    |  |
|----|--|
| No | Yes → Consult the error code guide matrix. |
|    |  |
22. Place the Massbus enable/disable switch on A1A12 in the enable (up) position.
23. Perform subsystem verification tests.
24. Are there error indications presented?  

|    |   |
|----|---|
| No | Yes → Use conventional system troubleshooting procedures. |
|    |   |
25. Return the disk drive to the customer.

DIA 0014

PATHFINDER LEVEL I

DIA 0014

You have arrived at this procedure from the error code guide matrix.

You are testing the tachometer circuits on the A1A5 PCA.

NOTE

Stack requirement for this diagnostic is spinning.

1. Place the FE local/norm switch in the FE local position.
2. Enter 'FE' in the FE panel keyboard.
3. Depress the enter/step switch.
4. Enter '14'.
5. Depress the enter/step switch.

NOTE

Step 6 enters parameters. A delay between the diagnostic cycles (value entered X 128 microseconds) may be entered. This delay increases the time between loops. For single cycle execution of the diagnostic test enter 'FF'. The cycle may be repeated by depressing the enter/step switch.

6. Enter parameter '11'.
7. Depress the enter/step switch.
8. Is one of the following error codes present in the data display?

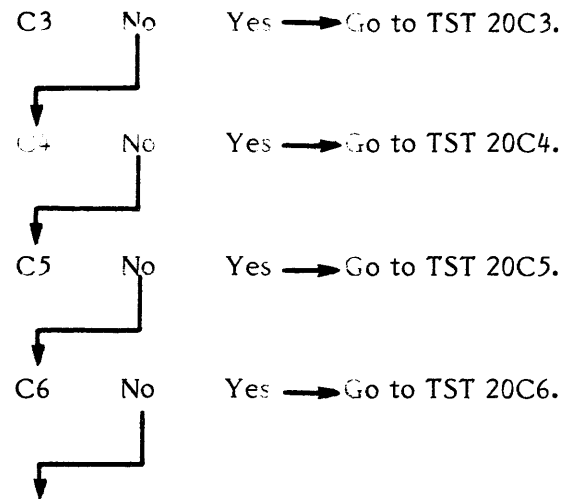
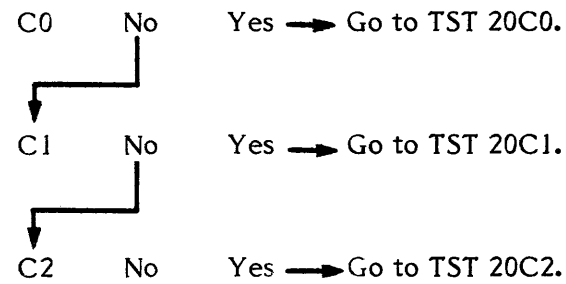

9. Place the FE local/norm switch in norm position.
10. Allow the drive to cycle up. Is there an error code displayed in the data display?

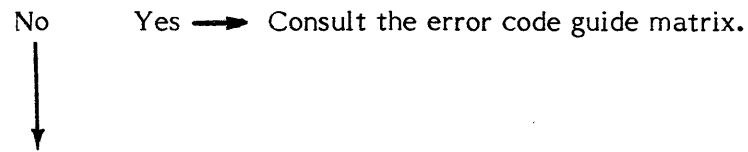

11. Place the Massbus enable/disable switch on A1A12 in the enable (up) position.
12. Perform subsystem verification tests.
13. Are there error indications presented?

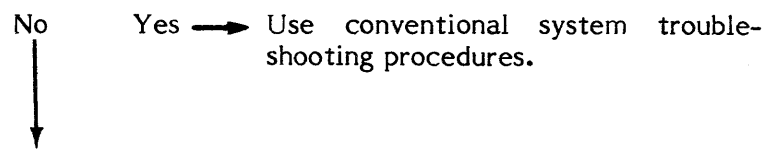

14. Return the disk drive to the customer.

**DIA 0018                      PATHFINDER LEVEL I                      DIA 0018**

You have arrived at this procedure from the error code guide matrix.

You are testing the PLO unsafe and index timing circuits.

**NOTE**  
Stack requirement for this diagnostic is spinning.

1. Place the FE local/norm switch in the FE local position.
2. Enter 'FE' in the FE panel keyboard.
3. Depress the enter/step switch.
4. Enter '18'.
5. Depress the enter/step switch.

**NOTE**  
Step 6 enters parameters. A delay between the diagnostic cycles (value entered X 128 microseconds) may be entered. This delay increases the time between loops. For single cycle execution of the diagnostic test enter 'FF'. The cycle may be repeated by depressing the enter/step switch.

6. Enter parameter '11'.
7. Depress the enter/step switch.
8. Is one of the following error codes present in the data display?

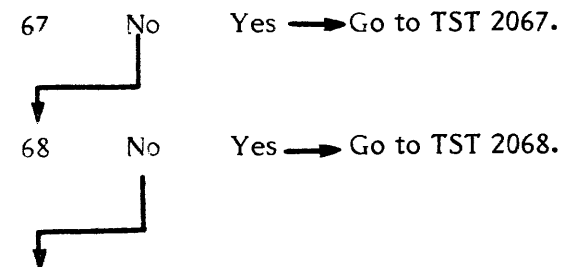

9. Place the FE local/norm switch in norm position.

10. Allow the drive to cycle up. Is there an error code displayed in the data display?

No                      Yes → Consult the error code guide matrix.



11. Place the Massbus enable/disable switch on A1A12 in the enable (up) position.

12. Perform subsystem verification tests.

13. Are there error indications presented?

No                      Yes → Use conventional system troubleshooting procedures.



14. Return the disk drive to the customer.

You have arrived at this procedure from the error code guide matrix.

You are testing the EMA driver reporting circuits.

**NOTE**

Stack requirement for this diagnostic is spinning.

1. Place the FE local/norm switch in the FE local position.
2. Enter 'FE' in the FE panel keyboard.
3. Depress the enter/step switch.
4. Enter '19'.
5. Depress the enter/step switch.

**NOTE**

Step 6 enters parameters. A delay between the diagnostic cycles (value entered X 128 microseconds) may be entered. This delay increases the time between loops. For single cycle execution of the diagnostic test enter 'FF'. The cycle may be repeated by depressing the enter/step switch.

6. Enter parameter '11'.
7. Depress the enter/step switch.
8. Is one of the following error codes present in the data display?

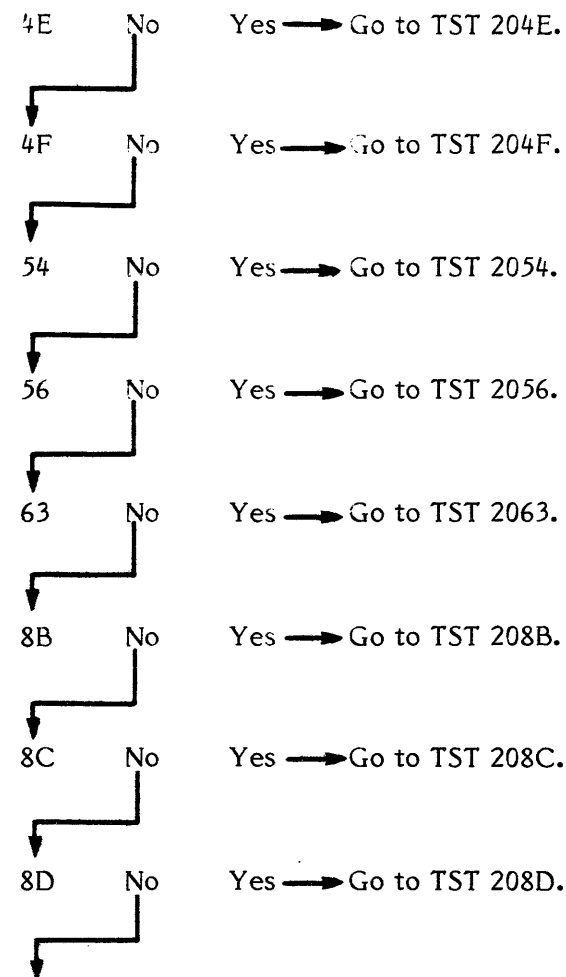
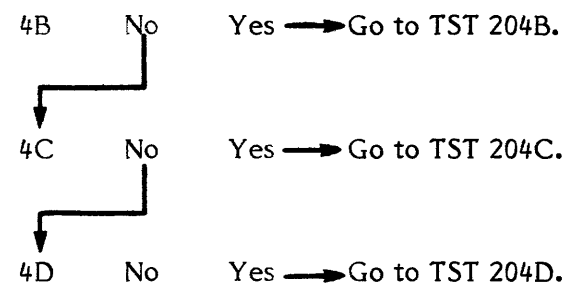

9. Place the FE local/norm switch in norm position.
10. Allow the drive to cycle up. Is there an error code displayed in the data display?
 

|    |  |
|----|--|
| No | Yes → Consult the error code guide matrix. |
| ↓  |  |
11. Place the Massbus enable/disable switch on A1A12 in the enable (up) position.
12. Perform subsystem verification tests.
13. Are there error indications presented?
 

|    |   |
|----|---|
| No | Yes → Use conventional system troubleshooting procedures. |
| ↓  |   |

14. Return the disk drive to the customer.

DIA 001A

## PATHFINDER LEVEL I

DIA 001A

You have arrived at this procedure from the error code guide matrix.

You are testing portions of the command index/sector PCA A1A8.

**NOTE**

Stack requirement for this diagnostic is spinning.

1. Place the FE local/norm switch in the FE local position.
2. Enter 'FE' in the FE panel keyboard.
3. Depress the enter/step switch.
4. Enter '1A'.
5. Depress the enter/step switch.

**NOTE**

Step 6 enters parameters. A delay between the diagnostic cycles (value entered X 128 microseconds) may be entered. This delay increases the time between loops. For single cycle execution of the diagnostic test enter 'FF'. The cycle may be repeated by depressing the enter/step switch.

6. Enter parameter '11'.
7. Depress the enter/step switch.
8. Observe the data display.
9. Is one of the following error codes present in the data display?

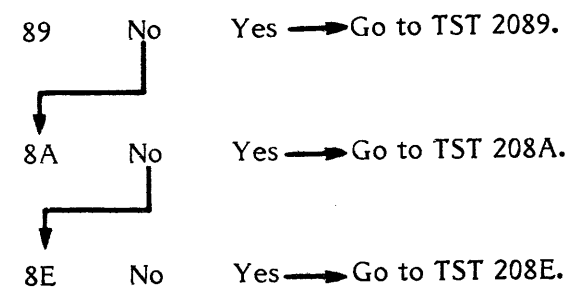

10. Place the FE local/norm switch in norm position.

11. Allow the drive to cycle up. Is there an error code displayed in the data display?

No      Yes → Consult the error code guide matrix.

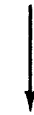

12. Place the Massbus enable/disable switch on A1A12 in the enable (up) position.

13. Perform subsystem verification tests.

14. Are there error indications presented?

No      Yes → Use conventional system troubleshooting procedures.



15. Return the disk drive to the customer.



**DIA 001B                      PATHFINDER LEVEL I                      DIA 001B**

You have arrived at this procedure from the error code guide matrix, or POS 0001, step 47, or TST 208A, step 34.

You are testing the R/W safety PCA A1A16.

**NOTE**

Stack requirement for this diagnostic is spinning.

1. Place the FE local/norm switch in the FE local position.
2. Enter 'FE' in the FE panel keyboard.
3. Depress the enter/step switch.
4. Enter '1B'.
5. Depress the enter/step switch.

**NOTE**

Step 10 enters parameters. A delay between the diagnostic cycles (value entered X 128 microseconds) may be entered. This delay increases the time between loops. For single cycle execution of the diagnostic test enter 'FF'. The cycle may be repeated by depressing the enter/step switch.

6. Enter parameter '11'.
7. Depress the enter/step switch.
8. Is one of the following error codes present in the data display?

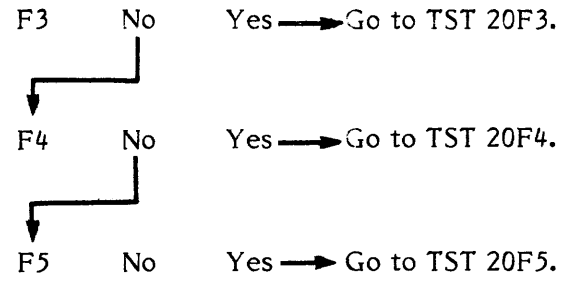
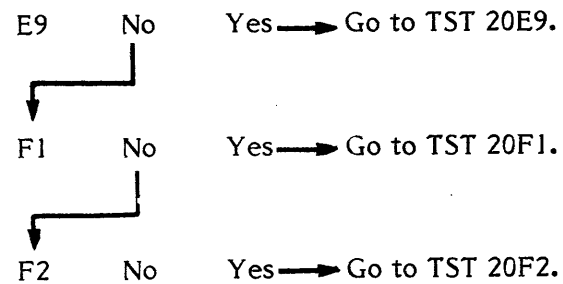

9. Place the FE local/norm switch in norm position.
10. Allow the drive to cycle up. Is there an error code displayed in the data display?
  - No      Yes → Consult the error code guide matrix.
11. Are you in this procedure because you are trying to isolate a functional read/write problem?
  - No      Yes → Go to DIA 001E.
12. Place the Massbus enable/disable switch on A1A12 in the enable (up) position.
13. Perform subsystem verification tests.
14. Are there error indications presented?
  - No      Yes → Use conventional system troubleshooting procedures.
15. Return the disk drive to the customer.

**DIA 001C                      PATHFINDER LEVEL I                      DIA 001C**

You have arrived at this procedure from the error code guide matrix; DIA 001D, step 10; or TST 208E, step 10.

You are testing the SERDES PCA A1A14.

**NOTE**

Stack requirement for this diagnostic is spinning.

1. Place the FE local/norm switch in the FE local position.
2. Enter 'FE' in the FE panel keyboard.
3. Depress the enter/step switch.
4. Enter 'IC'.
5. Depress the enter/step switch.

**NOTE**

Step 6 enters parameters. A delay between the diagnostic cycles (value entered X 128 microseconds) may be entered. This delay increases the time between loops. For single cycle execution of the diagnostic test enter 'FF'. The cycle may be repeated by depressing the enter/step switch.

6. Enter parameter '11'.
7. Depress the enter/step switch.
8. Is one of the following error codes present in the data display?

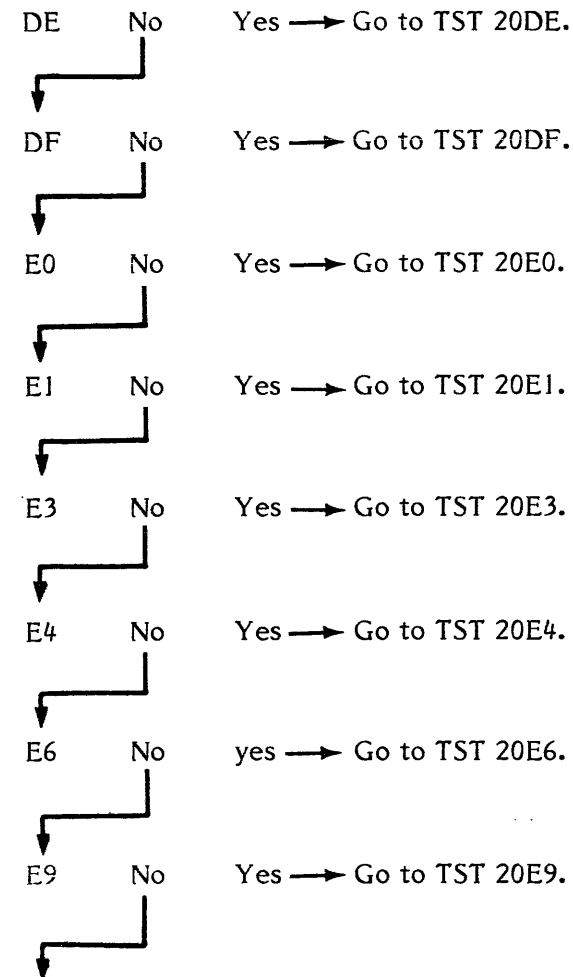
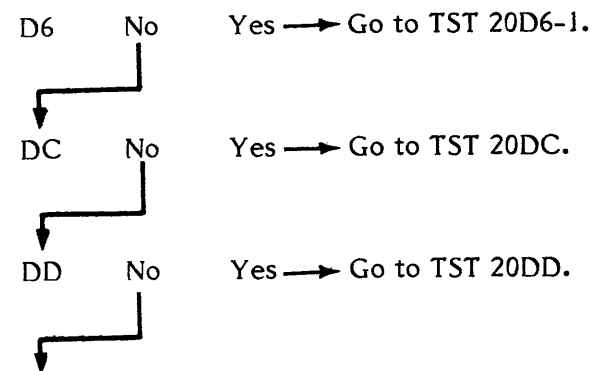

9. Place the FE local/norm switch in norm position.
10. Allow the drive to cycle up. Is there an error code displayed in the data display?
 

|    |  |
|----|--|
| No | Yes → Consult the error code guide matrix. |
|    |  |
11. Place the Massbus enable/disable switch on A1A12 in the enable (up) position.
12. Perform subsystem verification tests.
13. Are there error indications presented?
 

|    |   |
|----|---|
| No | Yes → Use conventional system troubleshooting procedures. |
|    |   |

14. Return the disk drive to the customer.

You have arrived at this procedure from the error code guide matrix.

You are testing the data encode/decode circuits

**NOTE**

Stack requirement for this diagnostic is spinning.

1. Place the FE local/norm switch in the FE local position.
2. Enter 'FE' in the FE panel keyboard.
3. Depress the enter/step switch.
4. Enter 'ID'.
5. Depress the enter/step switch.

**NOTE**

Step 6 enters parameters. A delay between the diagnostic cycles (value entered X 128 microseconds) may be entered. This delay increases the time between loops. For single cycle execution of the diagnostic test enter 'FF'. The cycle may be repeated by depressing the enter/step switch.

6. Enter parameter '11'.
7. Depress the enter/step switch.
8. Is one of the following error codes present in the data display?

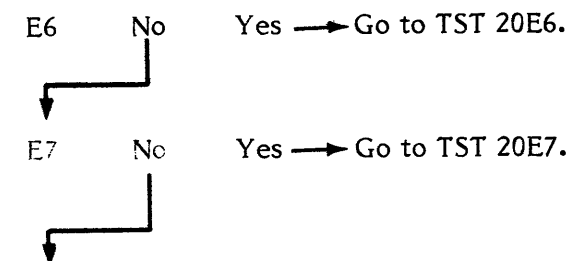

9. Depress reset.
10. Go to DIA 001C, step 4.

**DIA 001E PATHFINDER LEVEL I**

You have arrived at this procedure from the error code guide matrix, or from DIA 001B, step 11, or from POS 0001, step 47.

The stack must be spinning to use this procedure.

1. Place the FE local/norm switch in the FE local position.
2. Enter 'FE' in the FE panel keyboard.
3. Depress the enter/step switch.

**NOTE**

The purpose of the following steps, 4 through 10G, is to ascertain if all heads are failing. If at any time you determine that any head passes, go directly to step 11.

4. Enter 'IE'.
5. Depress the enter/step switch.

**NOTE**

Step 6 enters the head number that this diagnostic will use (00-1F). To ripple through all heads, enter '20'.

6. Enter '20'.
7. Depress the enter/step switch.
8. Enter '00'.
9. Depress the enter/step switch.
10. You are now attempting to run the 'read track descriptor' test. Let the test run for a few seconds. Is one of the following error codes displayed 'F6', 'F7', 'F8', or 'F9'?

**NOTE**

The error code may be intermittently displayed.

Yes No → Go to step 15.

10A. Depress reset.

- 10B. Enter '17'.
- 10C. Depress enter/step.
- 10D. Enter '8B' and depress enter/step.
- 10E. Read and record the data display. This is the head that failed while running 'IE'. Disregard the three high order bits.
- 10F. Depress reset.
- 10G. Is the head number recorded in step 10E equal to '00'?  
 Yes No → Some heads have passed. Save the failing head number from step 10E and go to step 11.  
 ↓
- 10H. Restart the diagnostic on a new head by repeating steps 4 through 10A. In step 6, enter a value one greater than the failing head number recorded in step 10E (e.g. if head 00 failed, enter '01'). Continue this process until all heads have been tested or a passing head is detected. Then go to step 11.

**NOTE**

It is not necessary to perform steps 10B through 10F any longer since you are now running only one head at a time. The head you test is the failing head as long as an error code occurs. If no error code occurs, the head passed, and you should go directly to step 11.

11. Did the routine ever present an error code of 'F6' in the data display?  
 Yes No → Go to step 14.  
 ↓
12. Did the errors occur on all heads?  
 Yes No → Go to TST 20FE.  
 ↓
13. Go to TST 20F6.

14. Did the routine present an error code of 'F8' or 'F9' in the data display?  
 No Yes → Go to TST 20F8.  
 ↓
15. Was any other error code present in the data display?  
 No Yes → Consult the error code guide matrix.  
 ↓
16. Depress the reset button on the FE control panel and enter '20' in the panel keyboard.
17. Depress the enter/step switch.
18. Enter '20'.
19. Depress the enter/step switch.
20. Enter '00'.
21. Depress the enter/step switch.
22. You are now running the 'write-read' test on all heads. Let the test run for a few seconds. If the test presents an 'F6', 'F7', 'F8', or 'F9' error code in the data display, read RAM location 188B to record the head address (disregard the three high order bits). Perform steps 10A through 10F of this procedure to read RAM location 188B and then go to step 23.
23. Did the diagnostic present an error code of 'F6' in the data display?  
 No Yes → Go to TST 20FF.  
 ↓
24. Did the routine present an error code of 'F8' or 'F9' in the data display?  
 No Yes → Go to TST 20F8.  
 ↓

25. Did the diagnostic stop with any other error code present in the data display?

No      Yes → Consult the error code guide matrix.



26. Depress the reset button on the FE control panel.

27. Enter '1F' in the FE panel keyboard.

28. Depress the enter/step switch.

29. Enter '00'.

30. Depress the enter/step switch.

31. Enter '11'.

32. Depress the enter/step switch.

33. Is error code 'F7' present in the data display?

No      Yes → Go to TST 20F7.



34. Place the Massbus enable/disable switch on A1A12 in the enable (up) position.

35. Perform subsystems verification tests.

36. Are there error indications presented?

No      Yes → Use conventional system troubleshooting procedures.



37. Return the disk drive to the customer.

THIS PAGE INTENTIONALLY LEFT BLANK

You have arrived at this procedure from the error code guide matrix.

You are testing the performance of the AM circuitry.

**NOTE**

Stack requirement for this diagnostic is spinning.

1. Place the FE local/norm switch in the FE local position.
2. Enter 'FE' in the FE panel keyboard.
3. Depress the enter/step switch.
4. Enter '22'.
- 4A. Depress the enter/step switch.
- 4B. Enter '00'.
5. Depress the enter/step switch.

**NOTE**

Step 6 enters parameters. A delay between the diagnostic cycles (value entered X 128 microseconds) may be entered. This delay increases the time between loops. For single cycle execution of the diagnostic test enter 'FF'. The cycle may be repeated by depressing the enter/step switch.

6. Enter parameter '11'.
7. Depress the enter/step switch.
8. Observe the data display.
9. Is one of the following error codes present in the data display?

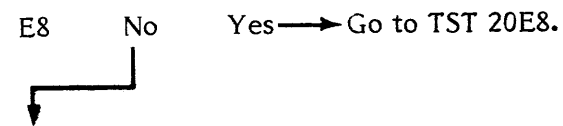

10. Place the FE local/norm switch in norm position.

11. Allow the drive to cycle up. Is there an error code displayed in the data display?

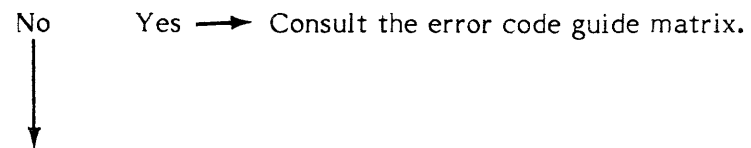

12. Place the Massbus enable/disable switch on A1A12 in the enable (up) position.
13. Perform subsystem verification tests.
14. Are there error indications presented?

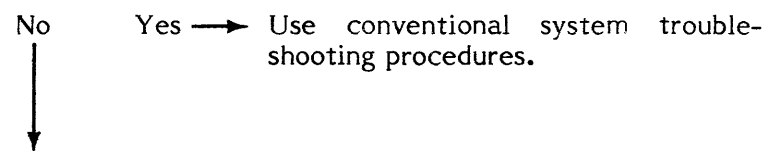

15. Return the disk drive to the customer.

**DIA 0023                      PATHFINDER LEVEL I                      DIA 0023**

You have arrived at this procedure from the error code guide matrix.

You are testing the DCL CROM memory for bad parity.

**NOTE**

Stack requirement for this diagnostic is spinning.

1. Place the FE local/norm switch in the FE local position.
2. Enter 'FE' in the FE panel keyboard.
3. Depress the enter/step switch.
4. Enter '23'.
5. Depress the enter/step switch.

**NOTE**

Step 6 enters parameters. A delay between the diagnostic cycles (value entered X 128 microseconds) may be entered. This delay increases the time between loops. For single cycle execution of the diagnostic test enter 'FF'. The cycle may be repeated by depressing the enter/step switch.

6. Enter parameter 'FF'.
7. Depress the enter/step switch.

**NOTE**

If a CROM parity error does not occur, the program code display will momentarily display 'C0' and then display 'CF'. '00' will appear in the data display.

If a CROM parity error does occur, the address of the parity error will be displayed in the following manner:

High order byte - program code display.

Low order byte - data display.

The address range of the CROM is from 0000 to 0DFF.

8. Observe the program code display and the data display.
9. Is a CROM address present in the program display and the data display?  
 No            Yes → Record the CROM address and go to TST 208F.  
 ↓
10. Place the FE local/norm switch in norm position.
11. Allow the drive to cycle up. Is there an error code displayed in the data display?  
 No            Yes → Consult the error code guide matrix.  
 ↓
12. Place the Massbus enable/disable switch on A1A12 in the enable (up) position.
13. Perform subsystem verification tests.
14. Are there error indications presented?  
 No            Yes → Use conventional system troubleshooting procedures.  
 ↓
15. Return the disk drive to the customer.



You have arrived at this procedure from the error code guide matrix.

You are testing all ROMS on the A1A7 PCA

**NOTE**

Stack requirement for this diagnostic is either spinning or not spinning.

1. Place the FE local/norm switch in the FE local position.
2. Enter 'FE' in the FE panel keyboard.
3. Depress the enter/step switch.
4. Enter '24'.
5. Depress the enter/step switch.

**NOTE**

Step 6 enters parameters. A delay between the diagnostic cycles (value entered X 128 microseconds) may be entered. This delay increases the time between loops. For single cycle execution of the diagnostic test enter 'FF'. The cycle may be repeated by depressing the enter/step switch.

6. Enter parameter '11'.
7. Depress the enter/step switch.
8. Is one of the following error codes present in the data display?

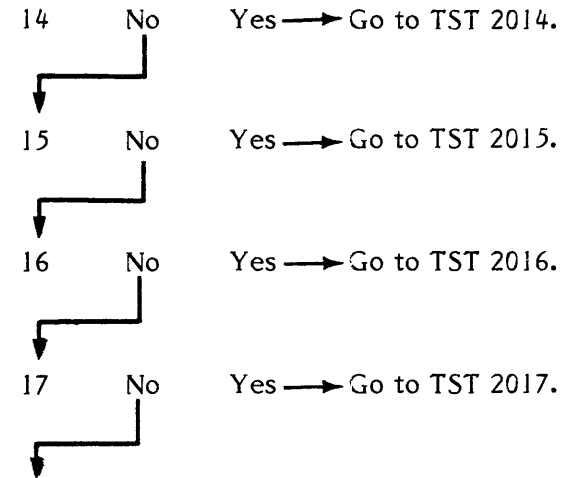
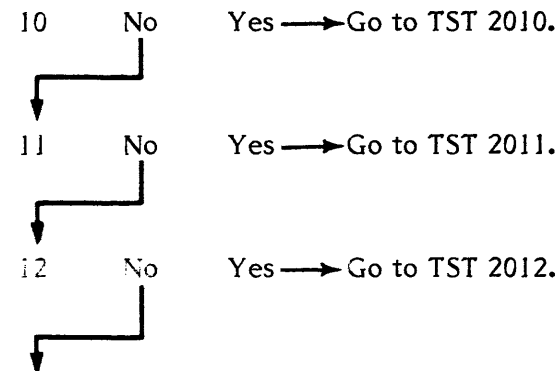

9. Place the FE local/norm switch in norm position.
- 9A. Place the start/stop switch in start position.
10. Allow the drive to cycle up. Is there an error code displayed in the data display?  
 No -> Step 11  
 Yes -> Consult the error code guide matrix.
11. Place the Massbus enable/disable switch on A1A12 in the enable (up) position.
12. Perform subsystem verification tests.
13. Are there error indications presented?  
 No -> Step 14  
 Yes -> Use conventional system troubleshooting procedures.
14. Return the disk drive to the customer.

**DIA 0025                      PATHFINDER LEVEL I                      DIA 0025**

You have arrived at this procedure from the error code guide matrix.

You are testing the input and the output ports on A1A7 PCA.

**NOTE**

Stack requirement for this diagnostic is either spinning or not spinning.

1. Place the FE local/norm switch in the FE local position.
2. Enter 'FE' in the FE panel keyboard.
3. Depress the enter/step switch.
4. Enter '25'.
5. Depress the enter/step switch.

**NOTE**

Step 6 enters parameters. A delay between the diagnostic cycles (value entered X 128 microseconds) may be entered. This delay increases the time between loops. For single cycle execution of the diagnostic test enter 'FF'. The cycle may be repeated by depressing the enter/step switch.

6. Enter parameter '11'.
7. Depress the enter/step switch.
8. Is one of the following error codes present in the data display?

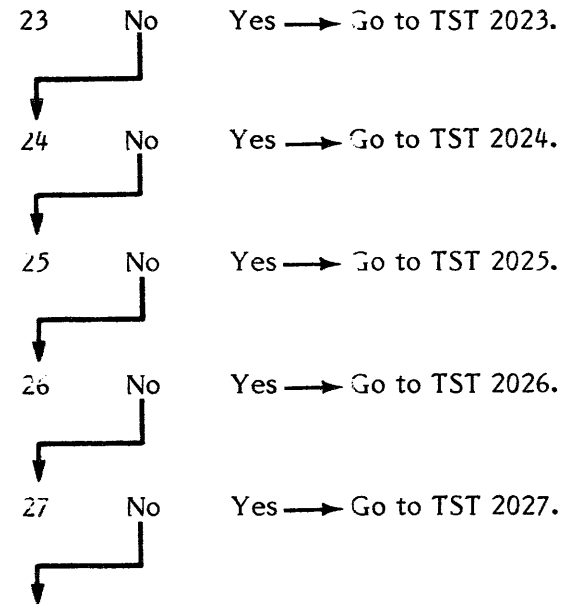
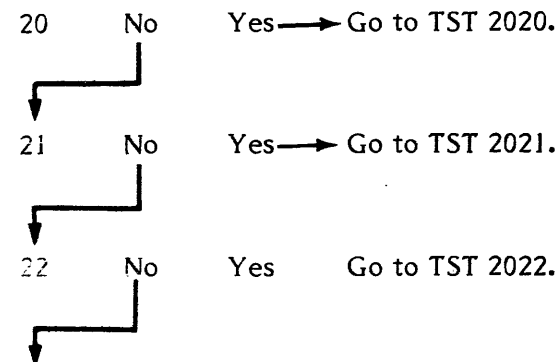

9. Place the FE local/norm switch in norm position.
- 9A. Place the start/stop switch in start position.
10. Allow the drive to cycle up. Is there an error code displayed in the data display?
  - No
  - Yes → Consult the error code guide matrix.
11. Place the Massbus enable/disable switch on A1A12 in the enable (up) position.
12. Perform subsystem verification tests.
13. Are there error indications presented?
  - No
  - Yes → Use conventional system troubleshooting procedures.
14. Return the disk drive to the customer.

You have arrived at this procedure from the error code guide matrix.

You are testing the interrupt circuits on the A1A7 PCA.

**NOTE**

Stack requirement for this diagnostic is either spinning or not spinning.

1. Place the FE local/norm switch in the FE local position.
2. Enter 'FE' in the FE panel keyboard.
3. Depress the enter/step switch.
4. Enter '26'.
5. Depress the enter/step switch.

**NOTE**

Step 6 enters parameters. A delay between the diagnostic cycles (value entered X 128 microseconds) may be entered. This delay increases the time between loops. For single cycle execution of the diagnostic test enter 'FF'. The cycle may be repeated by depressing the enter/step switch.

6. Enter parameter '11'.
7. Depress the enter/step switch.
8. Is one of the following error codes present in the data display?

3E      No      Yes → Go to TST 203E.

9. Place the FE local/norm switch in norm position.
- 9A. Place the start/stop switch in start position.

10. Allow the drive to cycle up. Is there an error code displayed in the data display?

No      Yes → Consult the error code guide matrix.



11. Place the Massbus enable/disable switch on A1A12 in the enable (up) position.
12. Perform subsystem verification tests.
13. Are there error indications presented?

No      Yes → Use conventional system troubleshooting procedures.



14. Return the disk drive to the customer.

DIA 0027

**PATHFINDER LEVEL I**

DIA 0027

You have arrived at this procedure from the error code guide matrix.

You are testing the CPU unsafe circuit on the A1A7 PCA.

**NOTE**

Stack requirement for this diagnostic is either spinning or not spinning.

1. Place the FE local/norm switch in the FE local position.
2. Enter 'FE' in the FE panel keyboard.
3. Depress the enter/step switch.
4. Enter '27'.
5. Depress the enter/step switch.

**NOTE**

Step 6 enters parameters. A delay between the diagnostic cycles (value entered X 128 microseconds) may be entered. This delay increases the time between loops. For single cycle execution of the diagnostic test enter 'FF'. The cycle may be repeated by depressing the enter/step switch.

6. Enter parameter '11'.
7. Depress the enter/step switch.
8. Is one of the following error codes present in the data display?

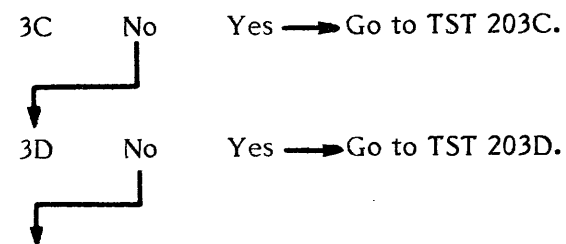

9. Place the FE local/norm switch in norm position.
- 9A. Place the start/stop switch in start position.

10. Allow the drive to cycle up. Is there an error code displayed in the data display?

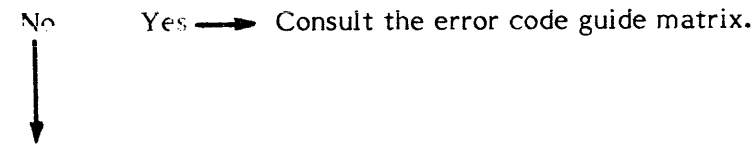

11. Place the Massbus enable/disable switch on A1A12 in the enable (up) position.
12. Perform subsystem verification tests.
13. Are there error indications presented?

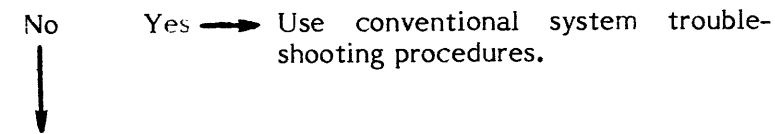

14. Return the disk drive to the customer.

You have arrived at this procedure from the error code guide matrix.

You are testing the timer circuits on A1A7.

**NOTE**

Stack requirement for this diagnostic is either spinning or not spinning.

1. Place the FE local/norm switch in the FE local position.
2. Enter 'FE' in the FE panel keyboard.
3. Depress the enter/step switch.
4. Enter '28'.
5. Depress the enter/step switch.

**NOTE**

Step 6 enters parameters. A delay between the diagnostic cycles (value entered X 128 microseconds) may be entered. This delay increases the time between loops. For single cycle execution of the diagnostic test enter 'FF'. The cycle may be repeated by depressing the enter/step switch.

6. Enter parameter '11'.
7. Depress the enter/step switch.
8. Is one of the following error codes present in the data display?

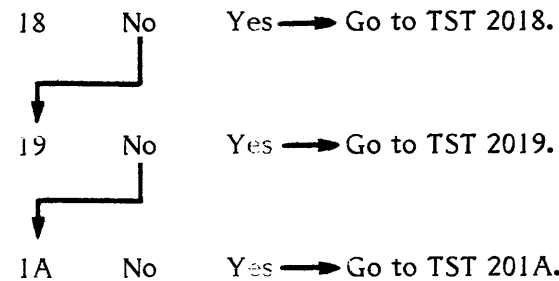

9. Place the FE local/norm switch in norm position.
- 9A. Place the start/stop switch in start position.
10. Allow the drive to cycle up. Is there an error code displayed in the data display?  
 No      Yes → Consult the error code guide matrix.  
 ↓
11. Place the Massbus enable/disable switch on A1A12 in the enable (up) position.
12. Perform subsystem verification tests.
13. Are there error indications presented?  
 No      Yes → Use conventional system troubleshooting procedures.  
 ↓
14. Return the disk drive to the customer.

**DIA 0029                      PATHFINDER LEVEL I                      DIA 0029**

You have arrived at this procedure from the error code guide matrix.

You are testing the EFF's data bus.

**NOTE**

Stack requirement for this diagnostic is either spinning or not spinning.

1. Place the FE local/norm switch in the FE local position.
2. Enter 'FE' in the FE panel keyboard.
3. Depress the enter/step switch.
4. Enter '29.'
5. Depress the enter/step switch.

**NOTE**

Step 6 enters parameters. A delay between the diagnostic cycles (value entered X 128 microseconds) may be entered. This delay increases the time between loops. For single cycle execution of the diagnostic test enter 'FF'. The cycle may be repeated by depressing the enter/step switch.

6. Enter parameter '11'.
7. Depress the enter/step switch.
8. Is one of the following error codes present in the data display?

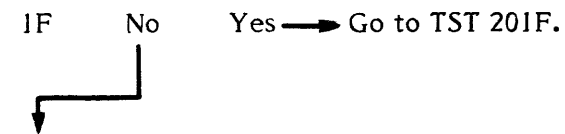

9. Place the FE local/norm switch in norm position.
- 9A. Place the start/stop switch in start position.

10. Allow the drive to cycle up. Is there an error code displayed in the data display?

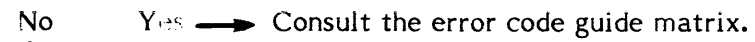

11. Place the Massbus enable/disable switch on A1A12 in the enable (up) position.

12. Perform subsystem verification tests.

13. Are there error indications presented?

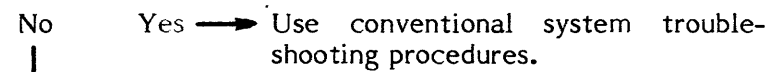

14. Return the disk drive to the customer.

You have arrived at this procedure from the error code guide matrix.

You are testing the Analog C RAM circuits.

**NOTE**



Stack requirement for this diagnostic is either spinning or not spinning.

1. Place the FE local/norm switch in the FE local position.
2. Enter 'FE' in the FE panel keyboard.
3. Depress the enter/step switch.
4. Enter '2A.'
5. Depress the enter/step switch.

**NOTE**

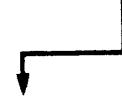
Step 6 enters parameters. A delay between the diagnostic cycles (value entered X 128 microseconds) may be entered. This delay increases the time between loops. For single cycle execution of the diagnostic test enter 'FF'. The cycle may be repeated by depressing the enter/step switch.

6. Enter parameter '11'.
7. Depress the enter/step switch.
8. Is one of the following error codes present in the data display?  
60      No      Yes → Go to TST 2060.  

9. Depress the reset switch on the FE panel.
10. Enter '2A'.
11. Depress the enter/step switch.

12. Enter 'FF'.
13. Depress the enter step switch.
14. Is error code '60' present in the data display?  
No      Yes → Go to TST 2060.  

15. Place the FE local/norm switch in norm position.
16. Place the start/stop switch in start position.
17. Allow the drive to cycle up. Is there an error code displayed in the data display?  
No      Yes → Consult the error code guide matrix.  

18. Place the Massbus enable/disable switch on A1A12 in the enable (up) position.
19. Perform subsystem verification tests.
20. Are there error indications presented?  
No      Yes → Use conventional system troubleshooting procedures.  

21. Return the disk drive to the customer.

DIA 002B

**PATHFINDER LEVEL I**

DIA 002B

You have arrived at this procedure from the error code guide matrix.

You are testing the limits of conversion of the A/D converter.

**NOTE**

Stack requirement for this diagnostic is either spinning or not spinning.

1. Place the FE local/norm switch in the FE local position.
2. Enter 'FE' in the FE panel keyboard.
3. Depress the enter/step switch.
4. Enter '2B'.
5. Depress the enter/step switch.

**NOTE**

Step 6 enters parameters. A delay between the diagnostic cycles (value entered X 128 microseconds) may be entered. This delay increases the time between loops. For single cycle execution of the diagnostic test enter 'FF'. The cycle may be repeated by depressing the enter/step switch.

6. Enter parameter '11'.
7. Depress the enter/step switch.
8. Is one of the following error codes present in the data display?

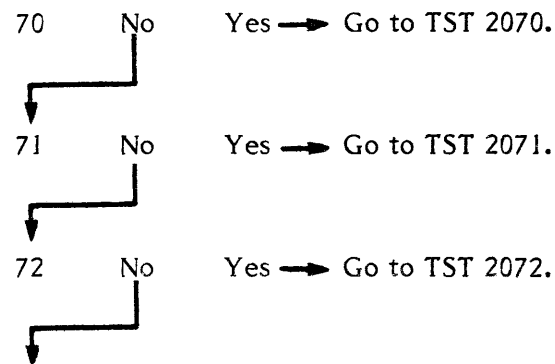

73      No      Yes → Go to TST 2073.



9. Place the FE local/norm switch in norm position.
- 9A. Place the start/stop switch in start position.
10. Allow the drive to cycle up. Is there an error code displayed in the data display?

No      Yes → Consult the error code guide matrix.



11. Place the Massbus enable/disable switch on A1A12 in the enable (up) position.
12. Perform subsystem verification tests.
13. Are there error indications presented?

No      Yes → Use conventional system troubleshooting procedures.



14. Return the disk drive to the customer.



You have arrived at this procedure from the error code guide matrix.

You are testing the performance of the D/A - A/D wrapback circuitry.

**NOTE**

Stack requirement for this diagnostic is either spinning or not spinning.

1. Place the FE local/norm switch in the FE local position.
2. Enter 'FE' in the FE panel keyboard.
3. Depress the enter/step switch.
4. Enter '2C'.
5. Depress the enter/step switch.

**NOTE**

Step 6 enters parameters. A delay between the diagnostic cycles (value entered X 128 microseconds) may be entered. This delay increases the time between loops. For single cycle execution of the diagnostic test enter 'FF'. The cycle may be repeated by depressing the enter/step switch.

6. Enter parameter '11'.
7. Depress the enter/step switch.
8. Observe the data display.
9. Is one of the following error codes present in the data display?

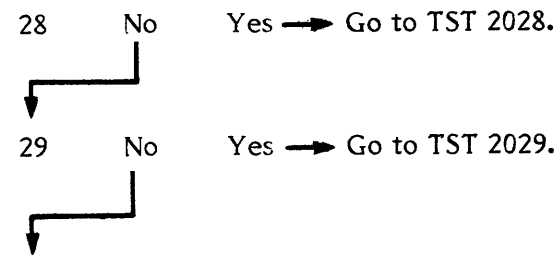

10. Place the FE local/norm switch in norm position.
- 10A. Place the start/stop switch in the start position.
11. Allow the drive to cycle up. Is there an error code in the data display?  
     No      Yes → Consult the error code guide matrix.  
     ↓
12. Place the Massbus enable/disable switch on A1A12 in the enable (up) position.
13. Perform subsystem verification tests.
14. Are there error indications presented?  
     No      Yes → Use conventional system troubleshooting procedures.  
     ↓
15. Return the disk drive to the customer.

**DIA 002D                      PATHFINDER LEVEL I                      DIA 002D**

You have arrived at this procedure from the error code guide matrix.

You are testing the performance of the 'difference position offset failure to calibrate' circuitry.

**NOTE**

Stack requirement for this diagnostic is either spinning or not spinning.

1. Place the start/stop switch in the stop position.
2. Place the FE local/norm switch in the FE local position.
3. Enter 'FE' in the FE panel keyboard.
4. Depress the enter/step switch.
5. Enter '2D'.
6. Depress the enter/step switch.

**NOTE**

Step 9 enters parameters. A delay between the diagnostic cycles (value entered X 128 microseconds) may be entered. This delay increases the time between loops. For single cycle execution of the diagnostic test enter 'FF'. The cycle may be repeated by depressing the enter/step switch.

7. Enter parameter '11'.
8. Depress the enter/step switch.
9. Observe the data display.
10. Is one of the following error codes present in the data display?

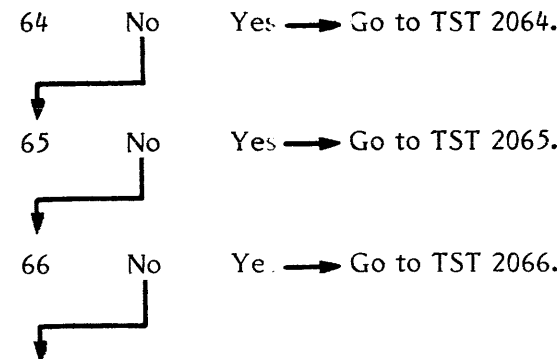
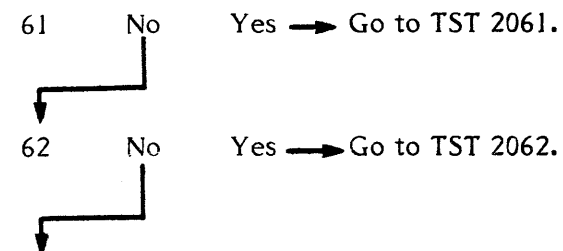

11. Place the FE local/norm switch in norm position.
  - 11A. Place the start/stop switch in the start position.
  12. Allow the drive to cycle up. Is there an error code present in the data display?
- 
- ```

    graph TD
      12[12] -- No --> 13[13]
      12 -- Yes --> T2066[Consult the error code guide matrix.]
  
```
13. Place the Massbus enable/disable switch on A1A12 in the enable (up) position.
  14. Perform subsystem verification tests.
  15. Are there error indications presented?
- 
- ```

    graph TD
      15[15] -- No --> 16[16]
      15 -- Yes --> T2066[Use conventional system troubleshooting procedures.]
  
```
16. Return the disk drive to the customer.

DIA 002E

PATHFINDER LEVEL I

DIA 002E

You have arrived at this procedure from the error code guide matrix.

You are testing the performance of the difference counter.

NOTE

Stack requirement for this diagnostic is either spinning or not spinning.

1. Place the FE local/norm switch in the FE local position.
2. Enter 'FE' in the FE panel keyboard.
3. Depress the enter/step switch.
4. Enter '2E'.
5. Depress the enter/step switch.

NOTE

Step 6 enters parameters. A delay between the diagnostic cycles (value entered X 128 microseconds) may be entered. This delay increases the time between loops. For single cycle execution of the diagnostic test enter 'FF'. The cycle may be repeated by depressing the enter/step switch.

6. Enter parameter '11'.
7. Depress the enter/step switch.
8. Observe the data display.
9. Is one of the following error codes present in the data display?

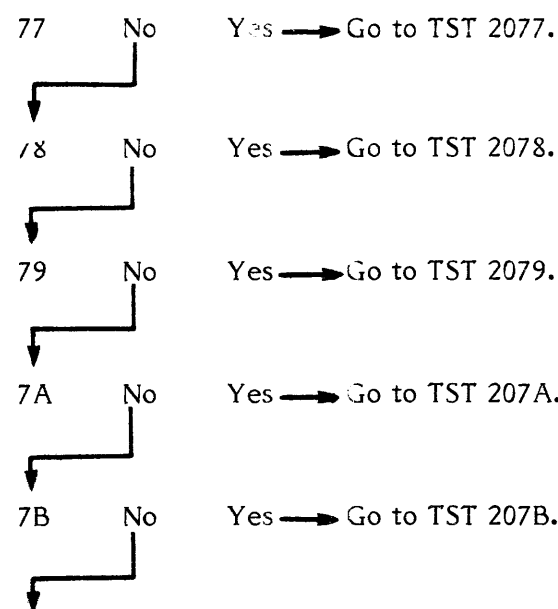
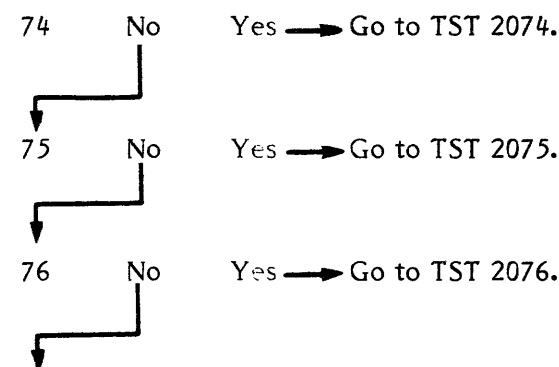

10. Place the FE local/norm switch in norm position.
- 10A. Place the start/stop switch in the start position.
11. Allow the drive to cycle up. Is there an error code displayed in the data display?  
 No Yes → Consult the error code guide matrix.  
 ↓
12. Place the Massbus enable/disable switch on A1A12 in the enable (up) position.
13. Perform subsystem verification tests.
14. Are there error indications presented?  
 No Yes → Use conventional system troubleshooting procedures.  
 ↓
15. Return the disk drive to the customer.

**DIA 002F                      PATHFINDER LEVEL I                      DIA 002F**

You have arrived at this procedure from the error code guide matrix.

You are testing the performance of the linear mode circuitry.

**NOTE**

Stack requirement for this diagnostic is either spinning or not spinning.

1. Place the FE local/norm switch in the FE local position.
2. Enter 'FE' in the FE panel keyboard.
3. Depress the enter/step switch.
4. Enter '2F'.
5. Depress the enter/step switch.

**NOTE**

Step 6 enters parameters. A delay between the diagnostic cycles (value entered X 128 microseconds) may be entered. This delay increases the time between loops. For single cycle execution of the diagnostic test enter 'FF'. The cycle may be repeated by depressing the enter/step switch.

6. Enter parameter '11'.
7. Depress the enter/step switch.
8. Observe the data display.
9. Is one of the following error codes present in the data display?

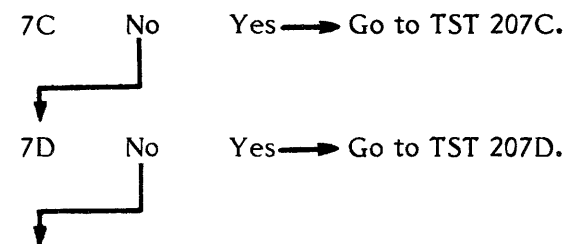

10. Place the FE local/norm switch in norm position.
- 10A. Place the start/stop switch in the start position.
11. Allow the drive to cycle up. Is there an error code displayed in the data display?
  - No
  - Yes → Consult the error code guide matrix.
12. Place the Massbus enable/disable switch on A1A12 in the enable (up) position.
13. Perform subsystem verification tests.
14. Are there error indications presented?
  - No
  - Yes → Use conventional system troubleshooting procedures.
15. Return the disk drive to the customer.

You have arrived at this procedure from the error code guide matrix.

You are testing the performance of the 'fine and coarse cylinder detect' circuitry.

**NOTE**

Stack requirement for this diagnostic is either spinning or not spinning.

1. Place the FE local/norm switch in the FE local position.
2. Enter 'FE' in the FE panel keyboard.
3. Depress the enter/step switch.
4. Enter '30'.
5. Depress the enter/step switch.

**NOTE**

Step 6 enters parameters. A delay between the diagnostic cycles (value entered X 128 microseconds) may be entered. This delay increases the time between loops. For single cycle execution of the diagnostic test enter 'FF'. The cycle may be repeated by depressing the enter/step switch.

6. Enter parameter '11'.
7. Depress the enter/step switch.
8. Observe the data display.
9. Is one of the following error codes present in the data display?

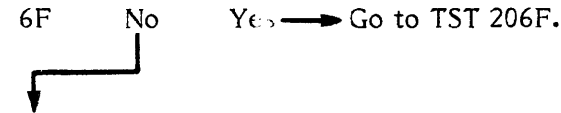
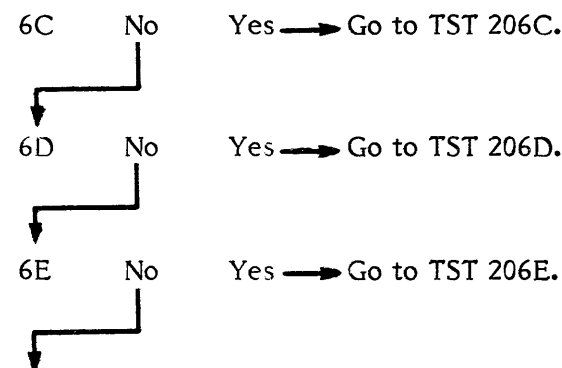

10. Place the FE local/norm switch in norm position.
- 10A. Place the start/stop switch in the start position.
11. Allow the drive to cycle up. Is there an error code displayed in the data display?

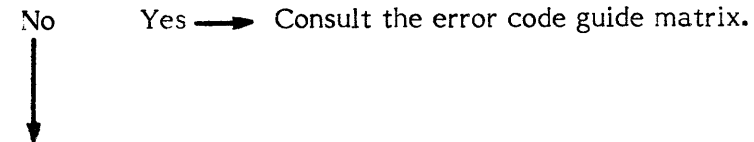

12. Place the Massbus enable/disable switch on A1A12 in the enable (up) position.
13. Perform subsystem verification tests.
14. Are there error indications presented?

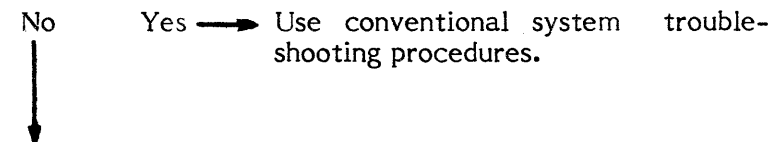

15. Return the disk drive to the customer.

**DIA 0031                      PATHFINDER LEVEL I**

You have arrived at this procedure from the error code guide matrix.

You are testing the performance of the test oscillator circuitry.

**NOTE**

Stack requirement for this diagnostic is either spinning or not spinning.

1. Place the FE local/norm switch in the FE local position.
2. Enter 'FE' in the FE panel keyboard.
3. Depress the enter/step switch.
4. Enter '31'.
5. Depress the enter/step switch.

**NOTE**

Step 6 enters parameters. A delay between the diagnostic cycles (value entered X 128 microseconds) may be entered. This delay increases the time between loops. For single cycle execution of the diagnostic test enter 'FF'. The cycle may be repeated by depressing the enter/step switch.

6. Enter parameter '11'.
7. Depress the enter/step switch.
8. Observe the data display.
9. Is one of the following error codes present in the data display?

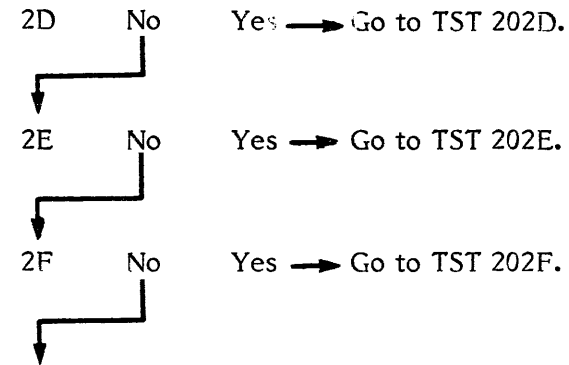
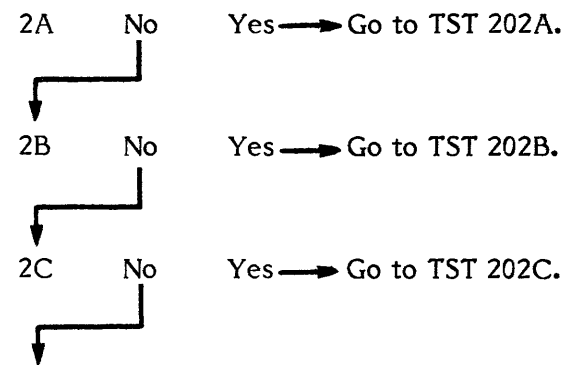

10. Place the FE local/norm switch in norm position.
- 10A. Place the start/stop switch in the start position.
11. Allow the drive to cycle up. Is there an error code displayed in the data display?
  - No
  - Yes → Consult the error code guide matrix.
12. Place the Massbus enable/disable switch on A1A12 in the enable (up) position.
13. Perform subsystem verification tests.
14. Are there error indications presented?
  - No
  - Yes → Use conventional system troubleshooting procedures.
15. Return the disk drive to the customer.

You have arrived at this procedure from the error code guide matrix.

You are testing the servo error amp circuits.

**NOTE**

Stack requirement for this diagnostic is either spinning or not spinning.

1. Place the FE local/norm switch in the FE local position.
2. Enter 'FE' in the FE panel keyboard.
3. Depress the enter/step switch.
4. Enter '32'.
5. Depress the enter/step switch.

**NOTE**

Step 6 enters parameters. A delay between the diagnostic cycles (value entered X 128 microseconds) may be entered. This delay increases the time between loops. For single cycle execution of the diagnostic test enter 'FF'. The cycle may be repeated by depressing the enter/step switch.

6. Enter parameter '11'.
7. Depress the enter/step switch.
8. Is one of the following error codes present in the data display?

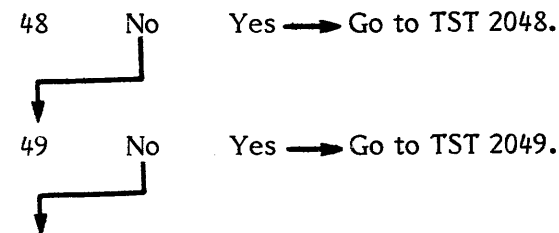

9. Place the FE local/norm switch in norm position.
- 9A. Place the start/stop switch in start position.

10. Allow the drive to cycle up. Is there an error code displayed in the data display?

No      Yes → Consult the error code guide matrix.



11. Place the Massbus enable/disable switch on A1A12 in the enable (up) position.

12. Perform subsystem verification tests.

13. Are there error indications presented?

No      Yes → Use conventional system troubleshooting procedures.



14. Return the disk drive to the customer.

**DIA 0033                      PATHFINDER LEVEL I                      DIA 0033**

You have arrived at this procedure from the error code guide matrix.

You are testing the performance of the curve generator circuitry.

**NOTE**

Stack requirement for this diagnostic is either spinning or not spinning.

1. Place the FE local/norm switch in the FE local position.
2. Enter 'FE' in the FE panel keyboard.
3. Depress the enter/step switch.
4. Enter '33'.
5. Depress the enter/step switch.

**NOTE**

Step 6 enters parameters. A delay between the diagnostic cycles (value entered X 128 microseconds) may be entered. This delay increases the time between loops. For single cycle execution of the diagnostic test enter 'FF'. The cycle may be repeated by depressing the enter/step switch.

6. Enter parameter '11'.
7. Depress the enter/step switch.
8. Observe the data display.
9. Is one of the following error codes present in the data display?

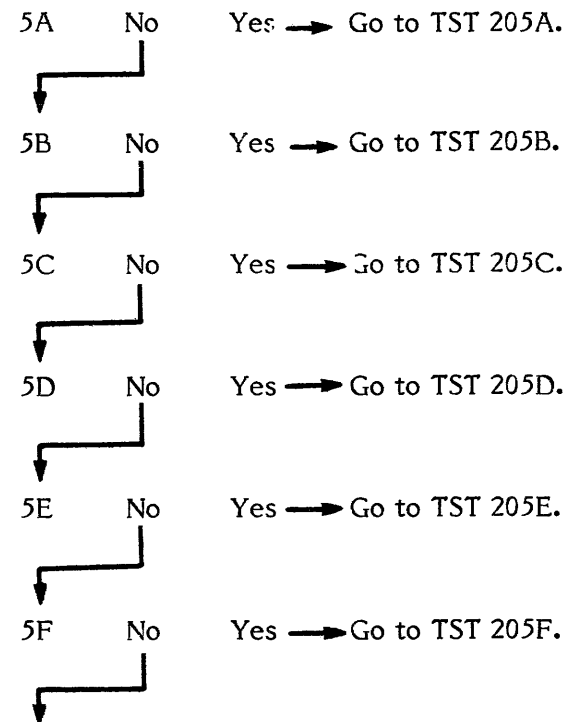
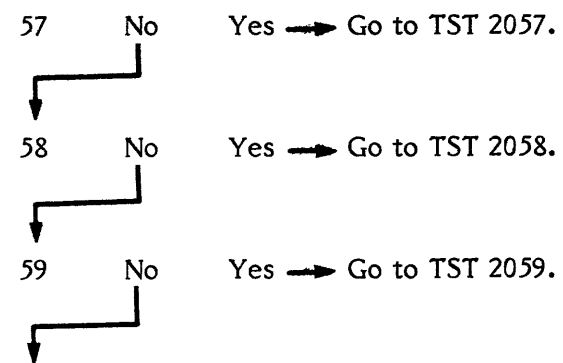

10. Place the FE local/norm switch in norm position.
- 10A. Place the start/stop switch in the start position.
11. Allow the drive to cycle up. Is there an error code displayed in the data display?
 

|    |  |
|----|--|
| No | Yes → Consult the error code guide matrix. |
| ↓  |  |
12. Place the Massbus enable/disable switch on A1A12 in the enable (up) position.
13. Perform subsystem verification tests.
14. Are there error indications presented?
 

|    |   |
|----|---|
| No | Yes → Use conventional system troubleshooting procedures. |
| ↓  |   |
15. Return the disk drive to the customer.



You have arrived at this procedure from the error code guide matrix.

You are testing the performance of the self wrap check on the communication register.

**NOTE**

Stack requirement for this diagnostic is either spinning or not spinning.

1. Place the FE local/norm switch in the FE local position.
2. Enter 'FE' in the FE panel keyboard.
3. Depress the enter/step switch.
4. Enter '34'.
5. Depress the enter/step switch.

**NOTE**

Step 6 enters parameters. A delay between the diagnostic cycles (value entered X 128 microseconds) may be entered. This delay increases the time between loops. For single cycle execution of the diagnostic test enter 'FF'. The cycle may be repeated by depressing the enter/step switch.

6. Enter parameter '11'.
7. Depress the enter/step switch.
8. Observe the data display.
9. Is one of the following error codes present in the data display?

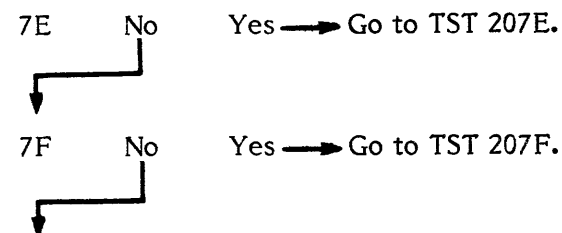

10. Place the FE local/norm switch in norm position.

- 10A. Place the start/stop switch in the start position.

11. Allow the drive to cycle up. Is there an error code displayed in the data display?

No      Yes → Consult the error code guide matrix.



12. Place the Massbus enable/disable switch on A1A12 in the enable (up) position.

13. Perform subsystem verification tests.

14. Are there error indications presented?

No      Yes → Use conventional system troubleshooting procedures.



15. Return the disk drive to the customer.

**DIA 0035                      PATHFINDER LEVEL I                      DIA 0035**

You have arrived at this procedure from the error code guide matrix.

You are testing CROM of DCL1 and DCL2.

**NOTE**

Stack requirement for this diagnostic is either spinning or not spinning.

1. Place the FE local/norm switch in the FE local position.
2. Enter 'FE' in the FE panel keyboard.
3. Depress the enter/step switch.
4. Enter '35'.
5. Depress the enter/step switch.

**NOTE**

Step 6 enters parameters. A delay between the diagnostic cycles (value entered X 128 microseconds) may be entered. This delay increases the time between loops. For single cycle execution of the diagnostic test enter 'FF'. The cycle may be repeated by depressing the enter/step switch.

6. Enter parameter '11'.
7. Depress the enter/step switch.
8. Is one of the following error codes present in the data display?

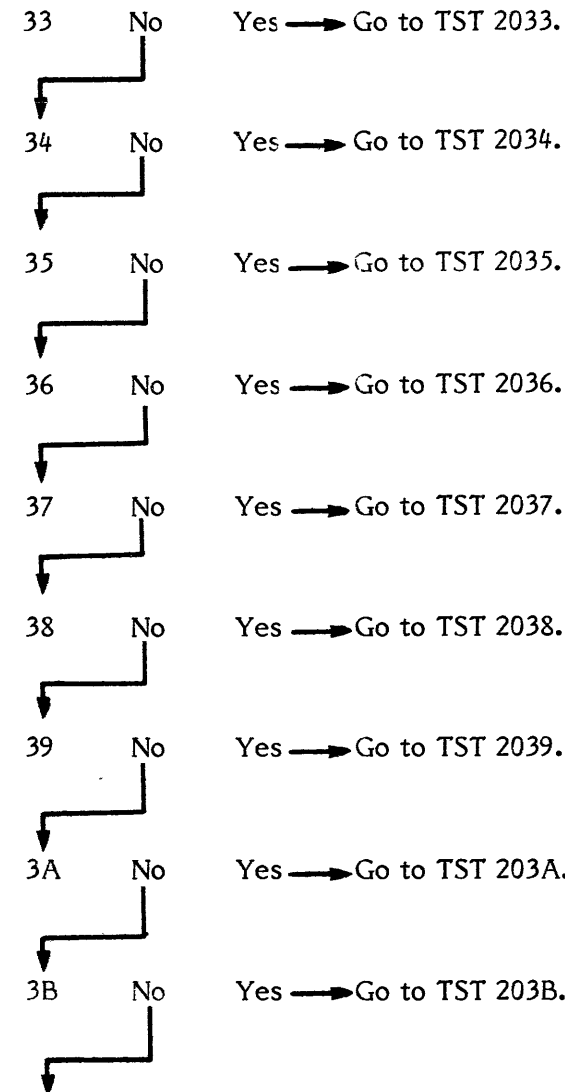
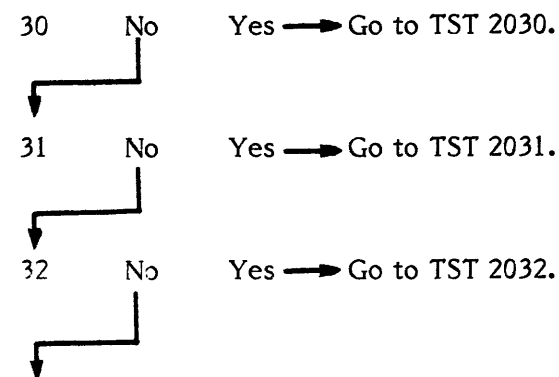

9. Place the FE local/norm switch in norm position.
- 9A. Place the start/stop switch in start position.
10. Allow the drive to cycle up. Is there an error code displayed in the data display?  
 No      Yes → Consult the error code guide matrix.
11. Place the Massbus enable/disable switch on A1A12 in the enable (up) position.
12. Perform subsystem verification tests.

13. Are there error indications presented?  
 No      Yes → Use conventional system troubleshooting procedures.
14. Return the disk drive to the customer.

DIA 0036

PATHFINDER LEVEL I

DIA 0036

You have arrived at this procedure from the error code guide matrix.

You are testing the DCL1 and the communication circuits.

NOTE

Stack requirement for this diagnostic is either spinning or not spinning.

1. Place the FE local/norm switch in the FE local position.
2. Enter 'FE' in the FE panel keyboard.
3. Depress the enter/step switch.
4. Enter '36'.
5. Depress the enter/step switch.

NOTE

Step 6 enters parameters. A delay between the diagnostic cycles (value entered X 128 microseconds) may be entered. This delay increases the time between loops. For single cycle execution of the diagnostic test enter 'FF'. The cycle may be repeated by depressing the enter/step switch.

6. Enter parameter '11'.
7. Depress the enter/step switch.
8. Is one of the following error codes present in the data display?

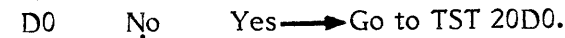
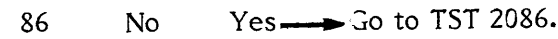
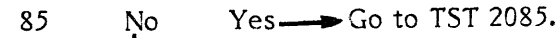
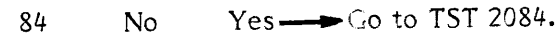
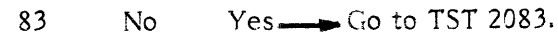
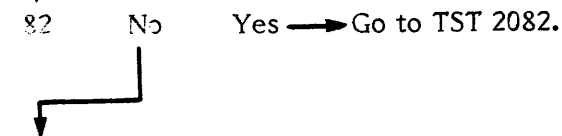
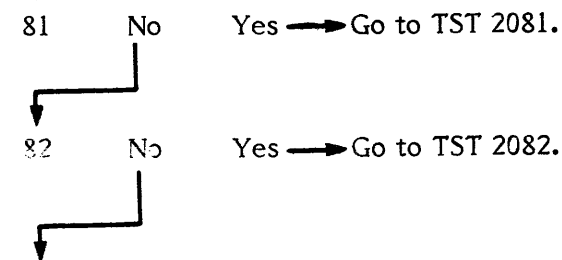
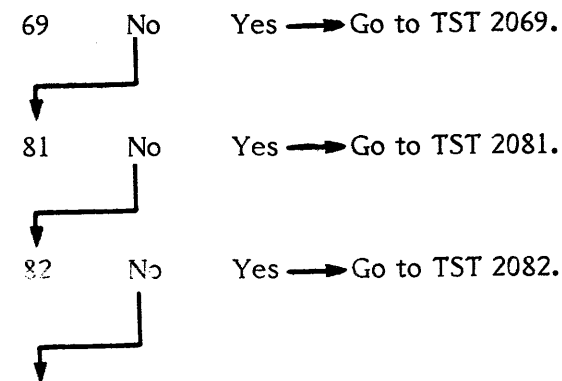

9. Depress reset.
10. Go to DIA 0037, step 4.

**DIA 0037                      PATHFINDER LEVEL I                      DIA 0037**

You have arrived at this procedure from the error code guide matrix or DIA 0036.

You are testing the DCL2 PCA A1A10.

**NOTE**

Stack requirement for this diagnostic is either spinning or not spinning.

1. Place the FE local/norm switch in the FE local position.
2. Enter 'FE' in the FE panel keyboard.
3. Depress the enter/step switch.
4. Enter '37'.
5. Depress the enter/step switch.

**NOTE**

Step 6 enters parameters. A delay between the diagnostic cycles (value entered X 128 microseconds) may be entered. This delay increases the time between loops. For single cycle execution of the diagnostic test enter 'FF'. The cycle may be repeated by depressing the enter/step switch.

6. Enter parameter '11'.
7. Depress the enter/step switch.
8. Is one of the following error codes displayed in the data display?

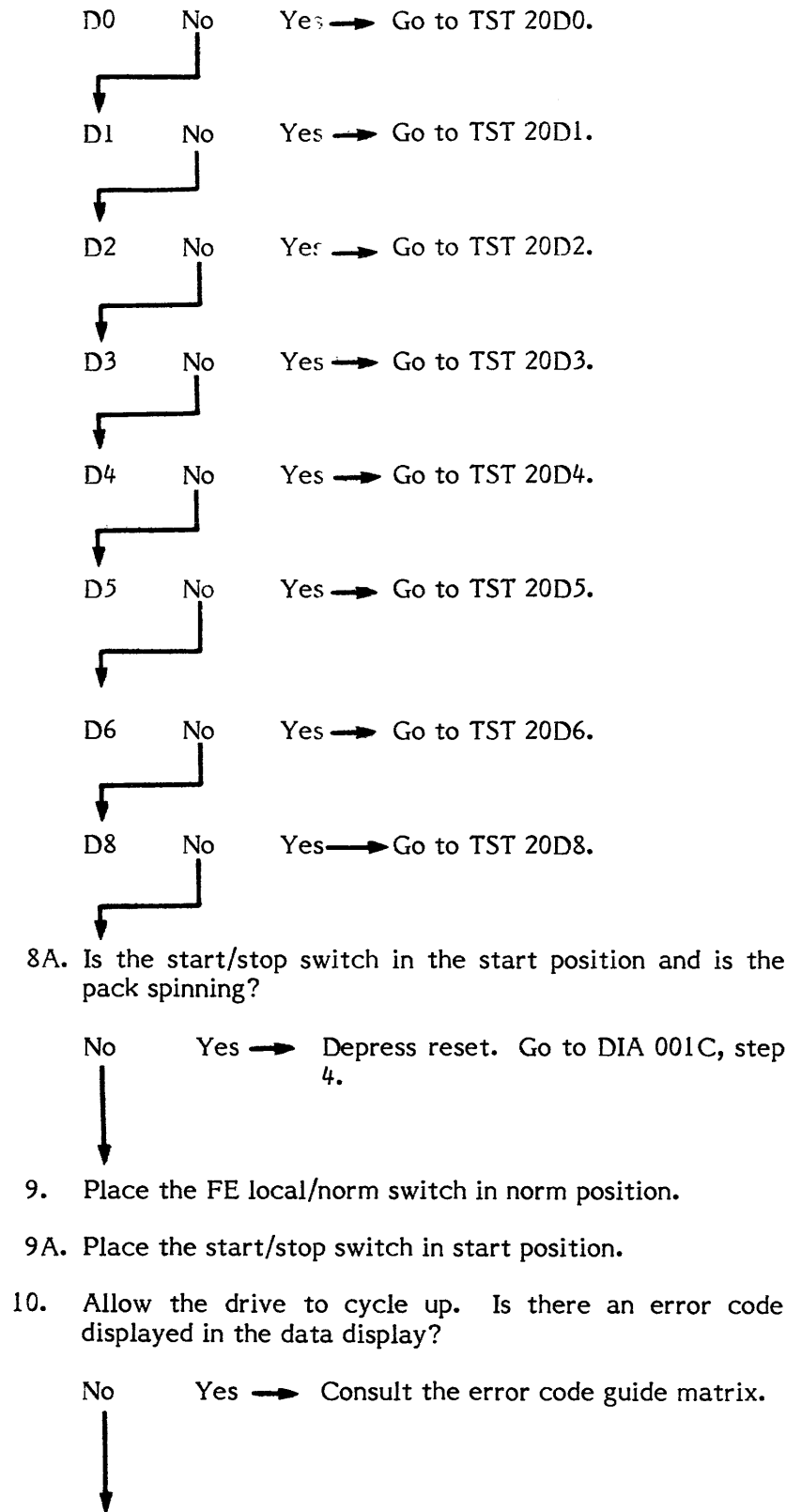
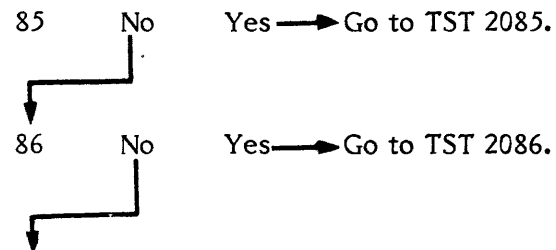

11. Place the Massbus enable/disable switch on A1A12 in the enable (up) position.
12. Perform subsystem verification tests.
13. Are there error indications presented?  
 No      Yes → Use conventional system troubleshooting procedures.
14. Return the disk drive to the customer.

You have arrived at this procedure from the error code guide matrix.

You are testing I/O control PCA A1A12 wrap.

**NOTE**

Stack requirement for this diagnostic is either spinning or not spinning.

1. Place the FE local/norm switch in the FE local position.
2. Enter 'FE' in the FE panel keyboard.
3. Depress the enter/step switch.
4. Enter '38'.
5. Depress the enter/step switch.

**NOTE**

Step 6 enters parameters. A delay between the diagnostic cycles (value entered X 128 microseconds) may be entered. This delay increases the time between loops. For single cycle execution of the diagnostic test enter 'FF'. The cycle may be repeated by depressing the enter/step switch.

6. Enter parameter '11'.
7. Depress the enter/step switch.
8. Is one of the following error codes present in the data display?

DA    No    Yes → Go to TST 20DA.

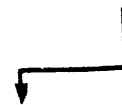

9. Place the FE local/norm switch in norm position.
- 9A. Place the start/stop switch in start position.

10. Allow the drive to cycle up. Is there an error code displayed in the data display?

No    Yes → Consult the error code guide matrix.



11. Place the Massbus enable/disable switch on A1A12 in the enable (up) position.
12. Perform subsystem verification tests.
13. Are there error indications presented?

No    Yes → Use conventional system troubleshooting procedures.



14. Return the disk drive to the customer.

**DIA 0039                      PATHFINDER LEVEL I                      DIA 0039**

You have arrived at this procedure from the error code guide matrix or from TST 208E, step 7.

You are testing the performance of the J12 PCA.

**NOTE**

Stack requirement for this diagnostic is either spinning or not spinning.

1. Place the FE local/norm switch in the FE local position.
2. Enter 'FE' in the FE panel keyboard.
3. Depress the enter/step switch.
4. Enter '39'.
5. Depress the enter/step switch.

**NOTE**

Step 6 enters parameters. A delay between the diagnostic cycles (value entered X 128 microseconds) may be entered. This delay increases the time between loops. For single cycle execution of the diagnostic test enter 'FF'. The cycle may be repeated by depressing the enter/step switch.

6. Enter parameter '11'.
7. Depress the enter/step switch.
8. Observe the data display.
9. Is one of the following error codes present in the data display?

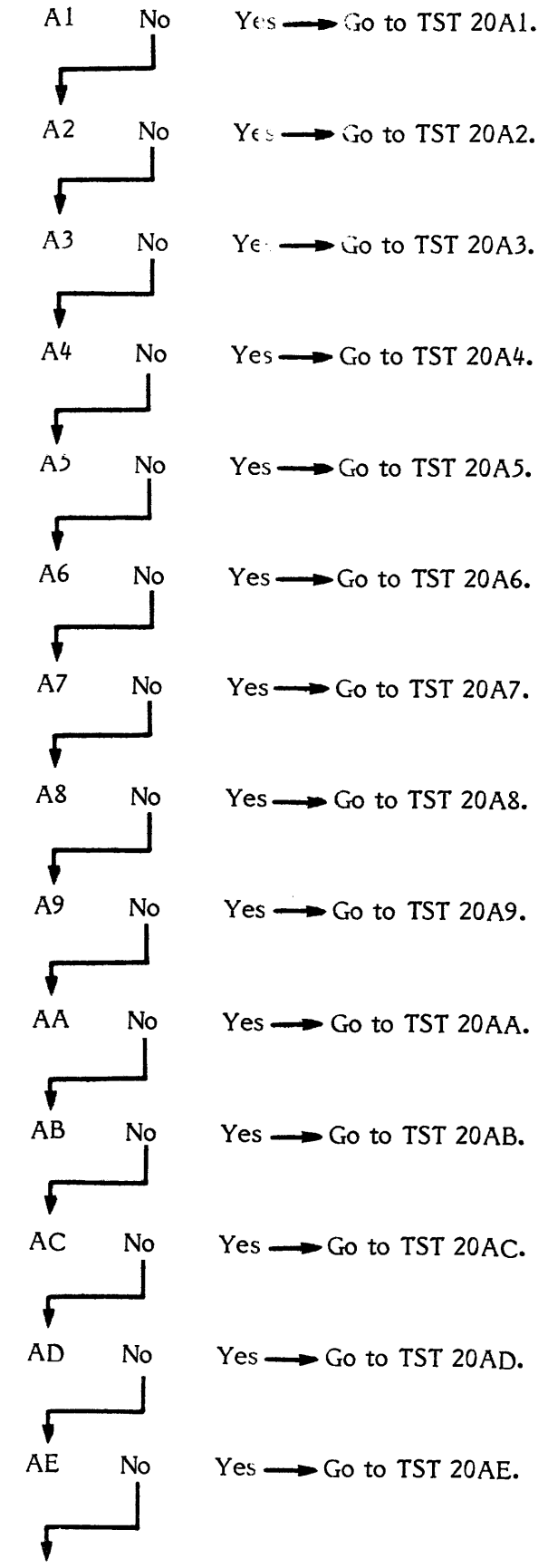
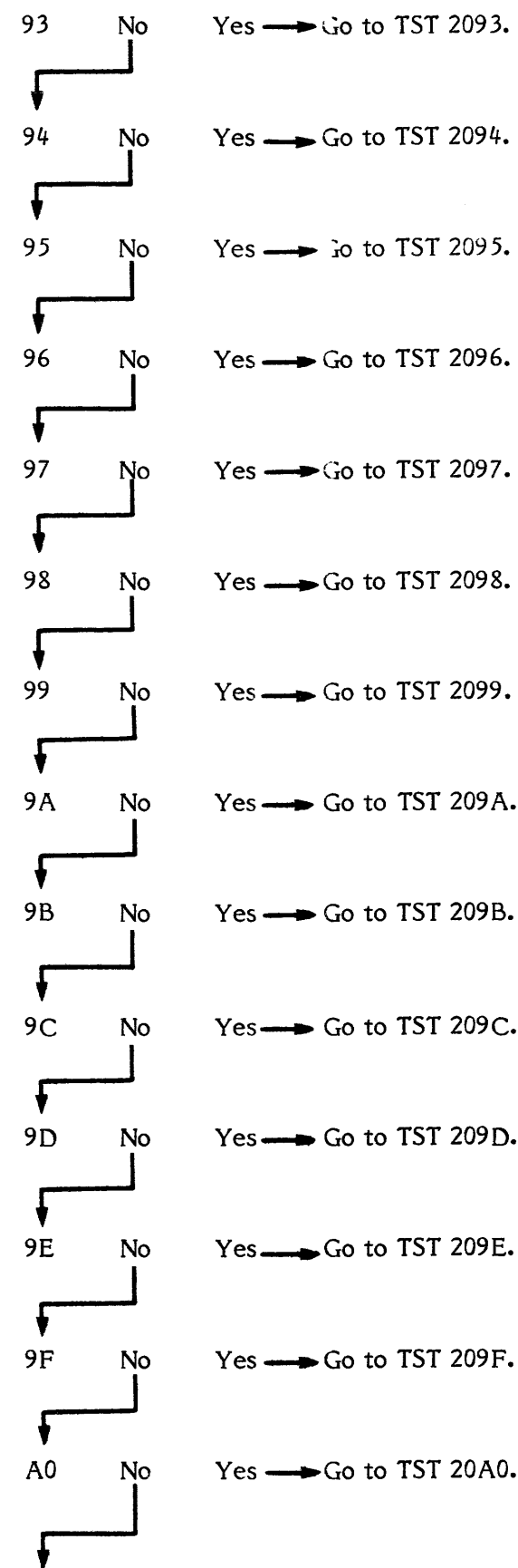
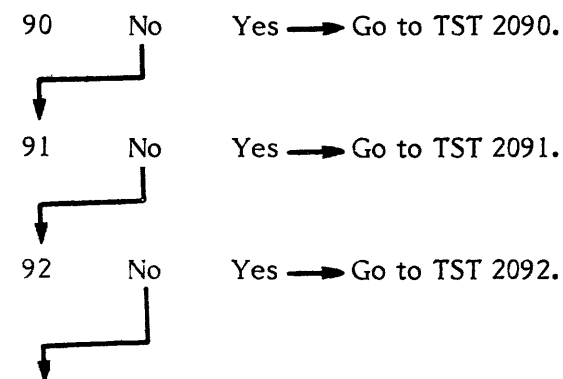

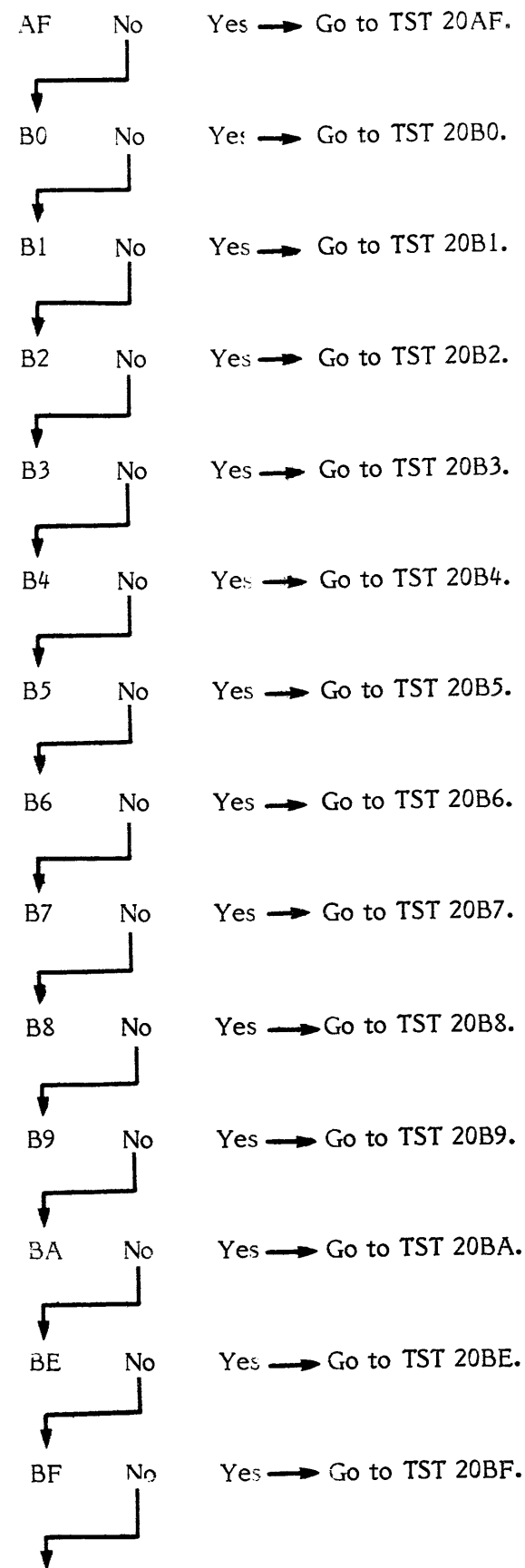

10. Place the FE local/norm switch in norm position.
11. Allow the drive to cycle up. Is there an error code displayed in the data display?
  - No
  - Yes → Consult the error code guide matrix.
12. Place the Massbus enable/disable switch on A1A12 in the enable (up) position.
13. Perform subsystem verification tests.
14. Are there error indications presented?
  - No
  - Yes → Use conventional system troubleshooting procedures.
15. Return the disk drive to the customer.

**DIA 003A                      PATHFINDER LEVEL I                      DIA 003A**

You have arrived at this procedure from the error code guide matrix.

You are testing the SERDES wrap.

**NOTE**

Stack requirement for this diagnostic is either spinning or not spinning.

1. Place the FE local/norm switch in the FE local position.
2. Enter 'FE' in the FE panel keyboard.
3. Depress the enter/step switch.
4. Enter '3A'.
5. Depress the enter/step switch.

**NOTE**

Step 6 enters parameters. A delay between the diagnostic cycles (value entered X 128 microseconds) may be entered. This delay increases the time between loops. For single cycle execution of the diagnostic test enter 'FF'. The cycle may be repeated by depressing the enter/step switch.

6. Enter parameter '11'.
7. Depress the enter/step switch.
8. Is one of the following error codes present in the data display?

E2      No      Yes → Go to TST 20E2.



9. Place the FE local/norm switch in norm position.
- 9A. Place the start/stop switch in start position.

10. Allow the drive to cycle up. Is there an error code displayed in the data display?

No      Yes → Consult the error code guide matrix.



11. Place the Massbus enable/disable switch on A1A12 in the enable (up) position.
12. Perform subsystem verification tests.
13. Are there error indications presented?

No      Yes → Use conventional system troubleshooting procedures.



14. Return the disk drive to the customer.



You have arrived at this procedure from the error code guide matrix.

You are testing read/write safety wrap check (A1A16).

**NOTE**

Stack requirement for this diagnostic is either spinning or not spinning.

1. Place the FE local/norm switch in the FE local position.
2. Enter 'FE' in the FE panel keyboard.
3. Depress the enter/step switch.
4. Enter '3B'.
5. Depress the enter/step switch.

**NOTE**

Step 6 enters parameters. A delay between the diagnostic cycles (value entered X 128 microseconds) may be entered. This delay increases the time between loops. For single cycle execution of the diagnostic test enter 'FF'. The cycle may be repeated by depressing the enter/step switch.

6. Enter parameter '11'.
7. Depress the enter/step switch.
8. Is one of the following error codes present in the data display?

F0      No      Yes → Go to TST 20F0.



9. Place the FE local/norm switch in norm position.
- 9A. Place the start/stop switch in start position.

10. Allow the drive to cycle up. Is there an error code displayed in the data display?

No      Yes → Consult the error code guide matrix.



11. Place the Massbus enable/disable switch on A1A12 in the enable (up) position.
12. Perform subsystem verification tests.
13. Are there error indications presented?

No      Yes → Use conventional system troubleshooting procedures.



14. Return the disk drive to the customer.

**DIA 088                    PATHFINDER LEVEL I                    DIA 0088**

You have arrived at this procedure from the error code guide matrix.

The diagnostic handling routine has failed to exit properly. One of the software flags did not set as it should.

When this problem occurs, error code '88' is presented.

1. Go to POS 0001, step 22.

That is all there is.

**Shorted Bus Test**

You have arrived at this routine from POS 0002, step 8 or 96.

The DC safe LED was not illuminated, but did illuminate when PCAs A1A4 through A1A17 and the HDA and operator's panel were unplugged.

1. Place the service switch in the Off (down) position. Reseat one PCA at a time placing the service switch to the On (up) position to observe the DC safe LED on A1A2, placing it in the Off (down) position again to reseat the next PCA. When the DC safe LED on A1A2 does not light, remove and replace the last PCA reseated and reseat the remaining PCAs.
2. Did you find a bad PCA?  
 Yes    No → Go to step 5.  
 ↓
3. Place the service switch in the On (up) position.
4. Is the DC safe LED on A1A2 illuminated?  
 Yes    No → Go to Pathfinder Level III, INF 3003.  
 ↓
5. Place the service switch in the Off (down) position and then place CB1 in the Off (down) position.
6. Plug in the operator's panel.
7. Place CB1 in the On (up) position and then place the service switch in the On (up) position.
8. Is the DC safe LED on A1A2 illuminated?  
 Yes    No → Place the service switch in the Off (down) position and then place CB1 in the Off (down) position. Remove and replace the operator's panel. Place CB1 in the On (up) position and then place the service switch in the On (up) position. If the DC safe LED on A1A2 is illuminated, go to step 9, else go to Pathfinder Level III, INF 3003.  
 ↓
9. Place the service switch in the Off (down) position.

10. Plug in the HDA.
11. Place the service switch in the On (up) position.
12. Is the DC safe LED on A1A2 illuminated?  
 No    Yes → Go to POS 0001, step 23.  
 ↓
13. Place the service switch in the Off (down) position.
14. Remove and replace the HDA.
15. Place the service switch in the On (up) position and observe the DC safe LED on A1A2. Is it illuminated?  
 Yes    No → Go to Pathfinder Level III, INF 3003.  
 ↓
16. Go to POS 0001, step 23.

**TST 0001                      PATHFINDER LEVEL II**

**Sequence in Progress Test**

You have arrived at this procedure from POS 0001, step 43 because the drive will not exit from program state '04'.

The purpose of this procedure is to isolate a problem in the power-on sequence circuits.

1. Is there a cable or shorting plug plugged into J18 on the backplane?

No      Yes → Go to step 4.

2. Install the plug or cable onto J18.

3. Is '04' displayed in the program code display?

Yes      No → Place the start/stop switch in the stop position and go to step 19.

4. Is this the only drive in the string?

No      Yes → Go to step 12.

5. Set the oscilloscope controls to the following settings:

Volts/cm:            0.5V (X10 probe)  
 Time/cm:            1.0 msec  
 Trigger Mode:        Automatic  
 Trigger Source:      Normal

6. Connect an insulated female scope probe from oscilloscope channel one to J080130 of the first drive in the string. Connect an insulated female jumper between the oscilloscope ground and J080033.
7. Observe the oscilloscope presentation.

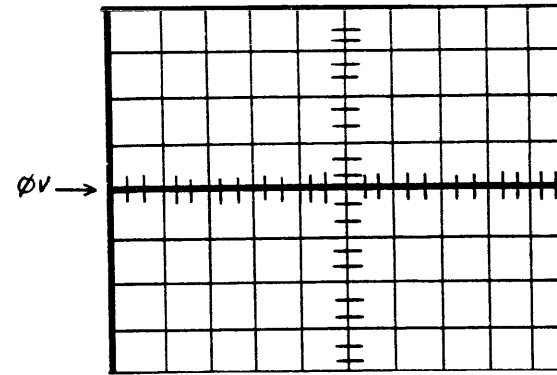

**NOTE**

You are looking for a constant 'low' (0 volts) signal.

8. Does the oscilloscope presentation look like the waveform illustrated above?

Yes      No → Go to step 12.

9. Starting with the last drive in the string, unplug the cable from J18 in each drive while observing the oscilloscope display. When the signal displayed on the oscilloscope goes high, perform the following steps on the last drive where a J18 cable was unplugged. If the signal displayed on the oscilloscope never goes high, go to step 12 and perform the subsequent steps on the first drive in the string.

10. Use an ohmmeter to check the cable that was unplugged from J18; check for continuity and that no wires are shorted to each other.

11. Is the cable ok?

Yes      No → Repair and go to step 17.

12. Place the start/stop switch in the stop position and CB1 in the Off (down) position.

13. Unplug any connectors that are on J18 or J19 and use an ohmmeter to check for continuity between the following points on the backplane:

| <u>FROM</u> | <u>TO</u> |
|-------------|-----------|
| J080129     | E005      |
| J080130     | E004      |
| J080131     | E006      |

**NOTE**

E4, E5 and E6 are located just to left of J18.

14. Did they check ok?

Yes      No → Repair as required and go to step 17.

15. Using an ohmmeter check the following pins to ground: E004, E005, E006. Are any of them shorted to ground?

No      Yes → Repair as required and go to step 17.

16. Remove and replace A1A8.

17. Reinstall any cables removed or any plugs unplugged in all drives.

18. Place CB1 in the On (up) position.

19. Place the start/stop switch in the start position.

20. Is there an '04' present in the program state display?

No      Yes → Go to Pathfinder Level III, INF 3004.

21. Go to POS 0001, step 44.

**FE Panel Performance Test**

You have arrived at this procedure from POS 0001, steps 12, 14, 17, 40, 42, or 45 because one of the functions of the FE panel did not operate properly.

1. Place the FE local/norm switch in the FE local position.
2. Place the start/stop switch in the stop position.
3. Place the service switch in the Off (down) position.

**NOTE**

The following sequence of events will occur when step 4 is performed:

- A. The LEDs on A1A7 will blink in a counting sequence (going from the bottom LED to the top LED).
- B. The LEDs on A1A7 and the LED digit displays on the FE control panel will display in succession: all 0's, all 1's, all 2's, etc. to all F's.

The LEDs on A1A7 are broken into two groups of four. Each group will display '0', '1', '2', etc. to 'F'.

- C. The program code display on the FE control panel will display '01' for about 15 seconds.

- D. The program code display will display 'CE'.

The entire sequence will take about 30 seconds to complete. You may have to place the service switch Off and On several times to insure that all of the events happen as described.

4. Place the service switch in the On (up) position.

5. Did the LEDs on A1A7 blink in a counting sequence as described in step 3A?

No      Yes → Go to step 27.



6. Set the oscilloscope controls to the following settings:

Volts/cm:            0.2V (X10 probe)  
 Time/cm:            1.0 msec  
 Trigger Mode:        Automatic  
 Trigger Source:      Normal

7. Connect an insulated female scope probe from oscilloscope channel one to J020048 (-POR or DC unsafe) and an insulated female jumper between oscilloscope ground and J020033.

8. Observe the oscilloscope presentation.

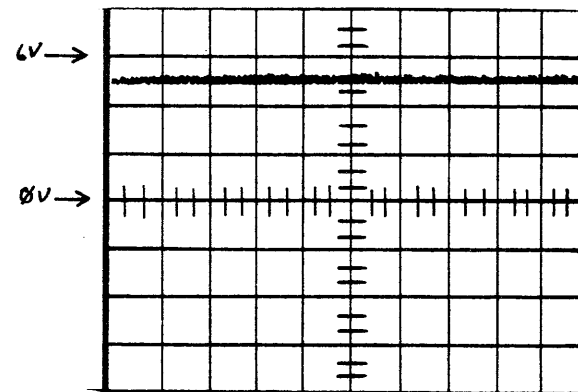

**NOTE**

You are looking for a DC level from 2.5 to 5 volts.

9. Does the oscilloscope presentation look like the waveform illustrated above?

No      Yes → Place the service switch in the Off (down) position. Remove and replace A1A7. Go to step 79.



10. Set the oscilloscope controls to the following settings:

Volts/cm:            0.5V (X10 probe)  
 Time/cm:            1.0 millisecond  
 Trigger Mode:        Automatic  
 Trigger Source:      Normal

11. Connect an insulated female scope probe from oscilloscope channel one to J010015 (+22 volts) and an insulated female jumper between oscilloscope ground and J010025.

12. Observe the oscilloscope presentation. The signal should be at a DC level of +22 +/-3 volts with no discernible ripple present. Is this so?

No      Yes → Go to step 21.



13. Place the service switch to the Off (down) position.

14. Place CBI in the Off (down) position.

15. Unplug the capacitor assembly from the rear of the A1A1.

**CAUTION**

The capacitors on the capacitor assembly may still be charged. Use a meter lead to short across the pins listed in step 16J before making the measurements.

16. Use an ohmmeter to check the following pins on J1 of the capacitor assembly. Allow a few seconds for the capacitors to charge when taking each reading. The diagram below shows the pin locations on J1.

Top

|    |    |    |
|----|----|----|
| 3  | 2  | 1  |
| 6  | 5  | 4  |
| 9  | 8  | 7  |
| 12 | 11 | 10 |

| Pin | to | Pin | Component  |
|-----|----|-----|--|
| 4   |    | 7   | Elect. capacitor                                 |
| 6   |    | 7   | Elect. capacitor                                 |
| 10  |    | 11  | Elect. capacitor                                 |
| 1   |    | 8   | 10 ohm resistor and elect. capacitor in parallel |
| 2   |    | 8   | 10 ohm resistor and elect. capacitor in parallel |

17. Are there any shorts or opens in the capacitor assembly?

No →  
Yes → Remove and replace the capacitor assembly. Place CBI in the On (up) position and go to step 79.

18. Remove and replace A1A1. Insure that CB4 and CB5 on A1A1 are reset (in).

19. Plug the capacitor assembly back into A1A1.

20. Place CBI in the On (up) position and go to step 79.

21. Place the service switch to the Off (down) position.

22. Unseat A1A5, A1A7 and A1A8.

23. Place the service switch to the On (up) position.

24. Does the oscilloscope presentation now look like the waveform illustrated in step 8?

Yes →  
No → Place the service switch in the Off (down) position and then place CBI in the Off (down) position. Remove and replace A1A2. Place CBI in the On (up) position and go to step 79.

25. Place the service switch in the Off (down) position. Reseat one PCA at a time placing the service switch in the On (up) position to observe the oscilloscope presentation, placing it Off (down) again to reseat the next PCA. When the oscilloscope presentation no longer looks like the waveform in step 8, remove and replace the last PCA reseated and reseat the remaining PCAs.

26. Go to step 79.

27. Did the LEDs on A1A7 correctly display the patterns described in step 3B?

Yes →  
No → Place the service switch in the Off (down) position. Remove and replace A1A7. Go to step 79.

28. Did the LED digit displays on the FE control panel correctly display the patterns described in step 3B?

No →  
Yes → Go to step 35.

29. Were the program code and data displays always equal in what they displayed?

**NOTE**  
Disregard the beginning and ending codes displayed.

Yes →  
No → Go to TST 0004.

30. Is error code '1F' displayed on the LED's on A1A7?

No →  
Yes → Go to TST 201F.

31. Go to TST 0004.

**NOTE**  
Steps 32 through 34 have been deleted.

35. Did the program code display change directly from '01' to 'CE' without any intervening codes displayed?

No →  
Yes → Go to step 45.

36. Place the service switch in the Off (down) position.

37. Place CBI in the Off (down) position.

38. Unplug the FE control panel from the backplane on J7.

39. Make sure that the FE local/norm switch is in the FE local position. Measure from P2, pin 58 to P2, pin 54 (P2 is the plug on the FE panel) with an ohmmeter.

40. Does the meter indicate a short?

Yes →  
No → Remove and replace the FE control panel. Place CBI in the On (up) position and go to step 79.

41. Plug the FE control panel back into the backplane on J7 (pins 41 through 80).

42. Remove and replace A1A7.

43. Place CBI in the On (up) position.

44. Go to step 79.

45. Enter 'FE' in the FE panel keyboard.

46. Did 'FE' appear in the data display?

Yes →  
No → Go to TST 0005.

47. Depress the enter/step switch.

48. Did 'FE' move to the program code display?

Yes →  
No → Place the service switch in the Off (down) position. Place CBI in the Off (down) position. Remove and replace the FE control panel. Place CBI in the On (up) position and go to step 79.

49. Enter '15' in the FE panel keyboard and depress the enter/step switch.

50. Does 'FF' appear in the program code display and the data display?

Yes →  
No → Place the service switch in the Off (down) position. Place CBI in the Off (down) position. Remove and replace the FE control panel. Place CBI in the On (up) position and go to step 79.

51. Enter '11' in the FE panel keyboard and depress the enter/step switch.

**NOTE**  
You are now running the FE panel diagnostic.

52. Depress each of the FE panel keyboard switches in succession (0 through F). As each switch is depressed, the corresponding number or letter should appear in all four LED digit displays.

53. Did all the switches cause a corresponding display in the digit displays?

Yes      No → Place the service switch in the Off (down) position. Place CBI in the Off (down) position. Remove and replace the FE control panel. Place CBI in the On (up) position and go to step 79.

54. Place the following switches in the indicated positions.

| <u>Switch</u> | <u>Position</u> |
|---------------|-----------------|
| Start/Stop    | Stop            |
| Online        | Down            |
| Write Protect | Down            |
| Access A or B | A               |

55. Place the service switch in the Off (down) position.

**NOTE**

When step 56 is performed, the following indicators should illuminate as indicated for about 15 seconds.

| <u>Indicator</u> | <u>Expected State</u> |
|------------------|-----------------------|
| Unsafe           | Constantly on         |
| Online           | Constantly on         |
| Write Protect    | Constantly on         |
| Access A         | Constantly on         |
| Access B         | Constantly on         |

56. Place the service switch in the On (up) position.

57. Did all the indicators listed in step 55 illuminate?

Yes      No → Place the service switch in the Off (down) position. Place CBI in the Off (down) position. Remove and replace the FE control panel. Place CBI in the On (up) position and go to step 79.

58. Wait an additional 15 seconds for 'CE' to appear in the program code display. Enter 'FE' in the FE panel keyboard and depress the enter/step switch.

59. Enter '15' and depress the enter/step switch.

60. Go to step 61.

61. The only indicator that should be illuminated is Access A. Is this so?

Yes      No → Go to step 66.

62. Place the following switches in the indicated positions.

| <u>Switch</u> | <u>Position</u> |
|---------------|-----------------|
| Start/Stop    | Stop            |
| Online        | Up              |
| Write Protect | Up              |
| Access A or B | B               |

63. The unsafe, online, write protect, and the Access B indicators should be illuminated. Is this so?

Yes      No → Go to step 66.

64. Place the Access A or B switch in the center (A-B) position.

65. Both the A and B indicators should be illuminated and the unsafe and online indicators should be blinking on and off. Is this so?

No      Yes → Go to step 79.

66. Place the service switch in the Off (down) position.

67. Place CBI in the Off (down) position.

68. Unplug the operators panel from the backplane on J7.

69. With the switches in the positions listed in step 54, make the following measurements with an ohmmeter. All points are on the operators panel plug.

| <u>FROM</u> | <u>TO</u> | <u>SHOULD BE</u> |
|-------------|-----------|------------------|
| P2-70       | P2-54     | Open             |
| P2-60       | P2-54     | Short            |
| P2-66       | P2-54     | Open             |
| P2-62       | P2-54     | Short            |
| P2-64       | P2-54     | Open             |

70. Were all of the measurements correct?

Yes      No → Remove and replace the FE operators panel. Place CBI in the On (up) position and go to step 79.

71. With the switches in the positions listed in step 62, make the following measurements with an ohmmeter. All points are on the operators panel plug.

| <u>FROM</u> | <u>TO</u> | <u>SHOULD BE</u> |
|-------------|-----------|------------------|
| P2-70       | P2-54     | Short            |
| P2-60       | P2-54     | Open             |
| P2-66       | P2-54     | Short            |
| P2-62       | P2-54     | Open             |
| P2-64       | P2-54     | Short            |

72. Were all of the measurements correct?

Yes      No → Remove and replace the FE operators panel. Place CBI in the On (up) position and go to step 79.

73. Place the Access A or B switch in the center (A-B) position.

74. Make the following measurements with an ohmmeter.

| <u>FROM</u> | <u>TO</u> | <u>SHOULD BE</u> |
|-------------|-----------|------------------|
| P2-62       | P2-54     | Open             |
| P2-64       | P2-54     | Open             |

75. Were all of the measurements correct?

Yes      No → Remove and replace the FE operators panel. Place CBI in the On (up) position and go to step 79.

76. Plug the operators panel back into the backplane on J7 (pins 41 through 80).

77. Place CBI in the On (up) position.

78. Remove and replace A1A7.

79. Place the service switch in the On (up) position and wait approximately 30 seconds.

80. Does 'CE' appear in the program code display?  
 Yes      No → Go to Pathfinder Level III, INF 3005.



81. Enter 'FE' in the FE panel keyboard and depress the enter/step switch.

82. Did 'FE' appear in the program code display?  
 Yes      No → Go to Pathfinder Level III, INF 3005.



83. Enter '15' and depress the enter/step switch.

84. Does 'FF' appear in the program code display as well as the data display?  
 Yes      No → Go to Pathfinder Level III, INF 3005.

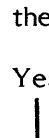

85. Go to step 86.

86. Depress each of the FE panel keyboard switches in succession (0 through F). As each switch is depressed, the corresponding number or letter should appear in all four LED digit displays.

87. Did all the switches cause a corresponding display in the digit displays?  
 Yes      No → Go to Pathfinder Level III, INF 3005.

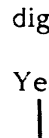

88. Place the following switches in the indicated positions:

| <u>Switch</u> | <u>Position</u> |
|---------------|-----------------|
| Start/Stop    | Stop            |
| Online        | Down            |
| Write Protect | Down            |
| Access A or B | A               |

89. The only indicator that should be illuminated is the Access A indicator. Is this so?  
 Yes      No → Go to Pathfinder Level III, INF 3005.



90. Place the following switches in the indicated positions:

| <u>Switch</u> | <u>Position</u> |
|---------------|-----------------|
| Start/Stop    | Start           |
| Online        | Up              |
| Write Protect | Up              |
| Access A or B | B               |

91. The unsafe, online, write protect, and the Access B indicators should be illuminated. Is this so?  
 Yes      No → Go to Pathfinder Level III, INF 3005.



92. Place the Access A or B switch in the center (A-B) position.

93. Both the A and B indicators should be illuminated and the unsafe and online indicators should be blinking on and off. Is this so?  
 Yes      No → Go to Pathfinder Level III, INF 3005.

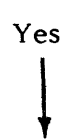

94. Depress the reset button.

95. Place the FE local/norm switch in the Normal position.

96. Wait for an '06' or '09' to appear in the program code display (wait approximately 90 seconds).

97. Is an '09' present in the program code display?  
 No      Yes → Read the error code present in the data display and consult the error code guide matrix.



98. Is '06' present in the program code display?  
 Yes      No → Go to Pathfinder Level III, INF 3005.



99. Place the Massbus enable/disable switch on A1A12 in the enable (up) position.

100. Perform subsystem verification tests.

101. Are there error indications presented?  
 No      Yes → Use conventional system troubleshooting procedures.



102. Return the disk drive to the customer.



**Diagnostic Interrupt Test**

You have arrived at this test from POS 0001, step 12A or 39A.

'0B' is present in the program code display when '03', '09' or 'CE' should be.

1. Place the service switch in the Off (down) position.
2. Unseat A1A12.
3. Place the service switch in the On (up) position and wait for '09', '0B', or 'CE' to appear in the program display.
4. Is '0B' present in the program code display?

Yes      No → Place the service switch in the Off (down) position. Remove and replace A1A12. Go to step 12.

↓

5. Place the service switch in the Off (down) position.
6. Unseat A1A8.
7. Place the service switch in the On (up) position and wait for '09', '0B' or 'CE' to appear in the program code display.
8. Is '0B' present in the program code display?

Yes      No → Place the service switch in the Off (down) position. Reseat A1A12 and remove and replace A1A8. Go to step 12.

↓

9. Place the service switch in the Off (down) position.
10. Reseat A1A12 and A1A8.
11. Remove and replace A1A7.
12. Insure that the FE local/norm switch is in the norm position.
13. Go to POS 0001, step 37.

TST 0004

## PATHFINDER LEVEL II

TST 0004

## Data Bus Test

You have arrived at this procedure from TST 0002, step 29 or 31 because there is a data bus problem with no '1F' error code posted on A1A7.

The purpose of this procedure is to isolate a problem in the data bus.

1. Place the service switch in the Off (down) position.
2. Unseat A1A4, A1A5, A1A6, A1A8 and A1A9.

**NOTE**

When step 3 is performed, the data display and program code display should display in succession all 1's, all 2's, all 3's, etc to all F's.

3. Place the service switch in the On (up) position.
4. Did all 4 LED digit displays on the control panel display all 1's, all 2's, all 3's, etc. to all F's?

Yes      No → Go to step 11.



5. Place the service switch in the Off (down) position.
6. Reseat one of the PCAs unseated in step 2.
7. Place the service switch in the On (up) position.
8. Did all 4 LED digit displays on the control panel display all 1's, all 2's, all 3's, etc. to all F's?

Yes      No → Place the service switch in the Off (down) position. Remove and replace the last PCA reseated and reseat any remaining unseated PCAs. Go to TST 0002, step 79.



9. Have all of the PCAs listed in step 2 been reseated?

No      Yes → Place the service switch in the Off (down) position and go to TST 0002, step 79.



10. Go to step 5.
11. Place the service switch in the Off (down) position.
12. Place CBI in the Off (down) position.
13. Reseat A1A4, A1A5, A1A6, A1A8 and A1A9.
14. Unplug the control panel.
15. Place CBI in the On (up) position.
16. Place the service switch to the On (up) position and wait approximately 60 seconds.
17. Do the LEDs on A1A7 display '60'?
 

|    |       |  |
|----|-------|--|
| No | Yes → | Place the service switch in the Off (down) position and then place CBI in the Off (down) position. Remove and replace A1A7 and plug the control panel back into the backpanel at J7 (pins 41 through 80). Go to step 79. |
| ↓  |       |  |
18. Place the service switch to the Off (down) position.
19. Place CBI in the Off (down) position.
20. Remove and replace the control panel.
21. Place CBI in the On (up) position.
22. Go to TST 0002, step 79.

**Data Bus Test**

You have arrived at this procedure from TST 0002, step 46 because there is a data bus problem with no '1F' error code posted on A1A7.

The purpose of this procedure is to isolate a problem in the data bus.

1. Place the service switch in the Off (down) position.
2. Unseat A1A4, A1A5, A1A6, A1A8 and A1A9.
3. Place the service switch in the On (up) position and wait for 'CE' to appear in the program code display.
4. Enter 'FE' in the FE panel keyboard.
5. Did 'FE' appear in the data display?  
 Yes    No    →    Go to step 13.  
 ↓
6. Place the service switch in the Off (down) position.
7. Reseat one of the PCAs unseated in step 2.
8. Place the service switch in the On (up) position and wait for 'CE' to appear in the program code display.
9. Enter 'FE' in the FE panel keyboard.
10. Did 'FE' appear in the data display?  
 Yes    No    →    Place the service switch in the Off (down) position. Remove and replace the last PCA reseated and reseat any remaining unseated PCAs. Go to TST 0002, step 79.  
 ↓
11. Have all of the PCAs listed in step 2 been reseated?  
 No    Yes    →    Place the service switch in the Off (down) position and go to TST 0002, step 79.  
 ↓
12. Go to step 6.
13. Place the service switch in the Off (down) position.

14. Place CB1 in the Off (down) position.
15. Reseat A1A4, A1A5, A1A6, A1A8 and A1A9.
16. Unplug the control panel.
17. Place CB1 in the On (up) position.
18. Place the service switch to the On (up) position and wait approximately 60 seconds.
19. Do the LEDs on A1A7 display '60'?  
 No    Yes    →    Place the service switch in the Off (down) position and then place CB1 in the Off (down) position. Remove and replace A1A7 and plug the control panel back into the backpanel at J7 (pins 41 through 80). Go to step 23.  
 ↓
20. Place the service switch to the Off (down) position.
21. Place CB1 in the Off (down) position.
22. Remove and replace the control panel.
23. Place CB1 in the On (up) position.
24. Go to TST 0002, step 79.

TST 2010                      PATHFINDER LEVEL II                      TST 2010

### CPU 0 to 2K PROM Test

You have arrived at this procedure from DIA 0024, step 8; DIA 0024 is still looping.

You are testing the CPU 0 to 2K PROM on the A1A07 PCA.

When there is a malfunction in these circuits error code '10' appears in the data display.

1. Place the service switch in the Off (down) position.
2. Remove and replace A1A7.
3. Place the FE local/norm switch in the norm position.
4. Place the service switch in the On (up) position.
5. Place the start/stop switch in the start position.
6. Is error code '10' present in the data display?

No      Yes → Go to Pathfinder Level III, INF 3024.



7. Is any other error code present in the data display?

No      Yes → Consult the error code guide matrix.



8. Place the Massbus enable/disable switch on A1A12 in the enable (up) position.

9. Perform subsystem verification tests.

10. Are there error indications presented?

No      Yes → Use conventional system troubleshooting procedures.



11. Return the disk drive to the customer.

**CPU 2K to 4K PROM Test**

You have arrived at this procedure from DIA 0024, step 8; DIA 0024 is still looping.

You are testing the CPU 2 to 4K PROM on the A1A07 PCA.

When there is a malfunction in these circuits error code '11' appears in the data display.

1. Place the service switch in the Off (down) position.
2. Remove and replace A1A7.
3. Place the FE local/norm switch in the norm position.
4. Place the service switch in the On (up) position.
5. Place the start/stop switch in the start position.
6. Is error code '11' present in the data display?

No      Yes → Go to Pathfinder Level III, INF 3024.



7. Is any other error code present in the data display?

No      Yes → Consult the error code guide matrix.



8. Place the Massbus enable/disable switch on A1A12 in the enable (up) position.
9. Perform subsystem verification tests.
10. Are there error indications presented?

No      Yes → Use conventional system troubleshooting procedures.



11. Return the disk drive to the customer.

## TST 2012                      PATHFINDER LEVEL II                      TST 2012

**CPU 4K to 6K PROM Test**

You have arrived at this procedure from DIA 0024, step 8; DIA 0024 is still looping.

You are testing the CPU 4K to 6K PROM on the A1A07 PCA.

When there is a malfunction in these circuits error code '12' appears in the data display.

1. Place the service switch in the Off (down) position.
2. Remove and replace A1A7.
3. Place the FE local/norm switch in the norm position.
4. Place the service switch in the On (up) position.
5. Place the start/stop switch in the start position.
6. Is error code '12' present in the data display?  
No      Yes → Go to Pathfinder Level III, INF 3024.  
↓
7. Is any other error code present in the data display?  
No      Yes → Consult the error code guide matrix.  
↓
8. Place the Massbus enable/disable switch on A1A12 in the enable (up) position.
9. Perform subsystem verification tests.
10. Are there error indications presented?  
No      Yes → Use conventional system trouble-shooting procedures.  
↓
11. Return the disk drive to the customer.

**RAM Test**

You have arrived at this procedure from DIA 0001, step 6.

You are testing the RAM circuitry.

This test is to verify the functions and circuits required to access RAM.

When there is a malfunction in these circuits error code '13' appears in the data display.

1. Place the start/stop switch in the stop position. Wait for the HDA to stop spinning.
2. Place the service switch in the Off (down) position.
3. Remove and replace A1A7.
4. Place the FE local/norm switch in the norm position.
5. Place the service switch in the On (up) position.
6. Place the start/stop switch in the start position.
7. Is error code '13' present in the data display?

No      Yes → Go to Pathfinder Level III, INF 3001.



8. Is any other error code present in the data display?

No      Yes → Consult the error code guide matrix.



9. Place the Massbus enable/disable switch on A1A12 in the enable (up) position.
10. Perform subsystem verification tests.
11. Are there error indications presented?

No      Yes → Use conventional system troubleshooting procedures.



12. Return the disk drive to the customer.

TST 2014                      PATHFINDER LEVEL II                      TST 2014

### CPU 6K to 8K PROM Test

You have arrived at this procedure from DIA 0024, step 8; DIA 0024 is still looping.

You are testing the CPU 6K to 8K PROM circuitry on the A1A07 PCA.

When there is a malfunction in these circuits error code '14' appears in the data display.

1. Place the service switch in the Off (down) position.
2. Remove and replace A1A7.
3. Place the FE local/norm switch in the norm position.
4. Place the service switch in the On (up) position.
5. Place the start/stop switch in the start position.
6. Is error code '14' present in the data display?  
No      Yes → Go to Pathfinder Level III, INF 3024.  
↓
7. Is any other error code present in the data display?  
No      Yes → Consult the error code guide matrix.  
↓
8. Place the Massbus enable/disable switch on A1A12 in the enable (up) position.
9. Perform subsystem verification tests.
10. Are there error indications presented?  
No      Yes → Use conventional system trouble-shooting procedures.  
↓
11. Return the disk drive to the customer.



**CPU 8K to 10K PROM Test**

You have arrived at this procedure from DIA 0024, step 8; DIA 0024 is still looping.

You are testing the CPU 8K to 10K PROM circuitry on the A1A07 PCA.

When there is a malfunction in these circuits error code '15' appears in the data display.

1. Place the service switch in the Off (down) position.
2. Remove and replace A1A7.
3. Place the FE local/norm switch in the norm position.
4. Place the service switch in the On (up) position.
5. Place the start/stop switch in the start position.
6. Is error code '15' present in the data display?

No      Yes → Go to Pathfinder Level III, INF 3024.



7. Is any other error code present in the data display?

No      Yes → Consult the error code guide matrix.



8. Place the Massbus enable/disable switch on A1A12 in the enable (up) position.
9. Perform subsystem verification tests.
10. Are there error indications presented?

No      Yes → Use conventional system troubleshooting procedures.



11. Return the disk drive to the customer.

TST 2016

PATHFINDER LEVEL II

TST 2016

**CPU 10K to 12K PROM Test**

You have arrived at this procedure from DIA 0024, step 8; DIA 0024 is still looping.

You are testing the CPU 10K to 12K PROM circuitry on the A1A07 PCA.

When there is a malfunction in these circuits error code '16' appears in the data display.

1. Place the service switch in the Off (down) position.
2. Remove and replace A1A7.
3. Place the FE local/norm switch in the norm position.
4. Place the service switch in the On (up) position.
5. Place the start/stop switch in the start position.
6. Is error code '16' present in the data display?

No      Yes → Go to Pathfinder Level III, INF 3024.



7. Is any other error code present in the data display?

No      Yes → Consult the error code guide matrix.



8. Place the Massbus enable/disable switch on A1A12 in the enable (up) position.
9. Perform subsystem verification tests.
10. Are there error indications presented?

No      Yes → Use conventional system troubleshooting procedures.



11. Return the disk drive to the customer.

**CPU 12K to 14K PROM Test**

You have arrived at this procedure from DIA 0024, step 8; DIA 0024 is still looping.

You are testing the CPU 12K to 14K PROM circuitry on the A1A07 PCA.

When there is a malfunction in these circuits error code '17' appears in the data display.

1. Place the service switch in the Off (down) position.
2. Remove and replace A1A7.
3. Place the FE local/norm switch in the norm position.
4. Place the service switch in the On (up) position.
5. Place the start/stop switch in the start position.
6. Is error code '17' present in the data display?

No      Yes → Go to Pathfinder Level III, INF 3024.



7. Is any other error code present in the data display?

No      Yes → Consult the error code guide matrix.



8. Place the Massbus enable/disable switch on A1A12 in the enable (up) position.
9. Perform subsystem verification tests.
10. Are there error indications presented?

No      Yes → Use conventional system troubleshooting procedures.



11. Return the disk drive to the customer.

TST 2018

PATHFINDER LEVEL II

TST 2018

**Timer 1 CPU Test**

You have arrived at this procedure from DIA 0028, step 8; DIA 0028 is still looping.

You are testing the Timer 1 circuitry on the A1A07 PCA.

When there is a malfunction in these circuits error code '18' appears in the data display.

1. Place the service switch in the Off (down) position.
2. Remove and replace A1A7.
3. Place the FE local/norm switch in the norm position.
4. Place the service switch in the On (up) position.
5. Place the start/stop switch in the start position.
6. Is error code '18' present in the data display?

No      Yes → Go to Pathfinder Level III, INF 3028.



7. Is any other error code present in the data display?

No      Yes → Consult the error code guide matrix.



8. Place the Massbus enable/disable switch on A1A12 in the enable (up) position.
9. Perform subsystem verification tests.
10. Are there error indications presented?

No      Yes → Use conventional system troubleshooting procedures.



11. Return the disk drive to the customer.

**Timer 2 CPU Test**

You have arrived at this procedure from DIA 0028, step 8; DIA 0028 is still looping.

You are testing the Timer 2 circuitry on the A1A07 PCA.

When there is a malfunction in these circuits error code '19' appears in the data display.

1. Place the service switch in the Off (down) position.
2. Remove and replace A1A7.
3. Place the FE local/norm switch in the norm position.
4. Place the service switch in the On (up) position.
5. Place the start/stop switch in the start position.
6. Is error code '19' present in the data display?

No      Yes → Go to Pathfinder Level III, INF 3028.



7. Is any other error code present in the data display?

No      Yes → Consult the error code guide matrix.



8. Place the Massbus enable/disable switch on A1A12 in the enable (up) position.
9. Perform subsystem verification tests.
10. Are there error indications presented?

No      Yes → Use conventional system trouble-shooting procedures.



11. Return the disk drive to the customer.

**Timer 3 CPU Test**

You have arrived at this procedure from DIA 0028, step 8; DIA 0028 is still looping.

You are testing the Timer 3 circuitry on the A1A07 PCA.

When there is a malfunction in these circuits error code '1A' appears in the data display.

- 1. Place the service switch in the Off (down) position.
- 2. Remove and replace A1A7.
- 3. Place the FE local/norm switch in the norm position.
- 4. Place the service switch in the On (up) position.
- 5. Place the start/stop switch in the start position.
- 6. Is error code '1A' present in the data display?

No      Yes → Go to Pathfinder Level III, INF 3028.  
 ↓

- 7. Is any other error code present in the data display?

No      Yes → Consult the error code guide matrix.  
 ↓

- 8. Place the Massbus enable/disable switch on A1A12 in the enable (up) position.
- 9. Perform subsystem verification tests.

- 10. Are there error indications presented?

No      Yes → Use conventional system trouble-shooting procedures.  
 ↓

- 11. Return the disk drive to the customer.

**Data Bus Failure**

You have arrived at this procedure from DIA 0029, step 8 or from TST 0002, step 8.

You are testing the 8080 external bus.

When there is a malfunction in these circuits error code '1F' appears in the data display.

1. Place the FE local/norm switch in the norm position.
2. Place the service switch in the Off (down) position.
3. Place CBI in the Off (down) position.
4. Unseat the following PCAs:
  - A1A4
  - A1A6
  - A1A8
  - A1A9
  - A1A10
  - A1A11
  - A1A12
  - A1A13
  - A1A14
  - A1A15
  - A1A16
5. Go to step 6.
6. Unplug the operators panel.
7. Place CBI in the Up (on) position.
8. Place the service switch in the On (up) position and wait approximately 30 seconds.
9. Is error code '1F' present in the A1A7 LEDs?
  - Yes    No → Go to step 18.
10. Place the service switch in the Off (down) position.
11. Reseat A1A4.
12. Unseat A1A5.
13. Place the service switch in the On (up) position and wait approximately 30 seconds.

14. Is error code '1F' present in the A1A7 LEDs?
  - No    Yes    Place the service switch in the down (off) position. Remove and replace A1A7. Go to step 30.
15. Place the service switch in the Off (down) position.
16. Remove and replace A1A5.
17. Go to step 30.
18. Place the service switch in the Off (down) position.
19. Place CBI in the Off (down) position.
20. Plug the operators panel back into the backpanel at J17 (pins 41 through 80).
21. Place CBI in the On (up) position.
22. Place the service switch in the On (up) position and wait approximately 30 seconds.
23. Is error code '1F' present in the A1A7 LEDs?
  - No    Yes → Place the service switch in the Off (down) position and CBI in the Off (down) position. Remove and replace the operators panel. Place CBI in the On (up) position and go to step 33.
24. Place the service switch in the Off (down) position.
25. Reseat one of the PCAs listed in step 4.
26. Place the service switch in the On (up) position and wait approximately 30 seconds.
27. Is error code '1F' present in the data display?
  - No    Yes → Place the service switch in the Off (down) position. Remove and replace the last PCA reseated in step 25. Go to step 33.
28. Have all of the PCAs listed in step 4 been reseated?
  - Yes    No → Go to step 24.
29. Go to step 33.
30. Place CBI in the Off (down) position.
31. Plug the operators panel back into the backpanel at J17 (pins 41 through 80).
32. Place CBI in the On (up) position.
33. Reseat all remaining unseated PCAs listed in step 4.
34. Go to step 38.
38. Place the FE local/norm switch in the norm position.
39. Place the service switch in the On (up) position.
40. Place the start/stop switch in the start position and wait approximately 90 seconds.
41. Is an error code '1F' present in the data display?
  - No    Yes → Go to Pathfinder Level III, INF 3029.
42. Is any other error code present in the data display?
  - No    Yes → Consult the error code guide matrix.
43. Place the Massbus enable/disable switch on A1A12 in the enable (up) position.
44. Perform subsystem verification tests.
45. Are there error indications presented?
  - No    Yes → Use conventional system troubleshooting procedures.
46. Return the disk drive to the customer.

TST 2020

PATHFINDER LEVEL II

TST 2020

**CPU Register Test**

You have arrived at this procedure from DIA 0025, step 8; DIA 0025 is still looping.

You are testing the CPU register circuitry on the A1A07 PCA.

When there is a malfunction in these circuits error code '20' appears in the data display.

1. Place the service switch in the Off (down) position.
2. Remove and replace A1A7.
3. Place the FE local/norm switch in the norm position.
4. Place the service switch in the On (up) position.
5. Place the start/stop switch in the start position.
6. Is error code '20' present in the data display?

No      Yes → Go to Pathfinder Level III, INF 3025.



7. Is any other error code present in the data display?

No      Yes → Consult the error code guide matrix.



8. Place the Massbus enable/disable switch on A1A12 in the enable (up) position.
9. Perform subsystem verification tests.
10. Are there error indications presented?

No      Yes → Use conventional system trouble-shooting procedures.



11. Return the disk drive to the customer.



**CPU Multiplexer Select Output Line Test**

You have arrived at this procedure from DIA 0025, step 8; DIA 0025 is still looping.

You are testing the CPU multiplexer select output line circuitry.

When there is a malfunction in these circuits error code '21' appears in the data display.

1. Place the service switch in the Off (down) position.
2. Remove and replace A1A7.
3. Place the FE local/norm switch in the norm position.
4. Place the service switch in the On (up) position.
5. Place the start/stop switch in the start position.
6. Is error code '21' present in the data display?

No      Yes → Go to Pathfinder Level III, INF 3025.



7. Is any other error code present in the data display?

No      Yes → Consult the error code guide matrix.



8. Place the Massbus enable/disable switch on A1A12 in the enable (up) position.
9. Perform subsystem verification tests.
10. Are there error indications presented?

No      Yes → Use conventional system trouble-shooting procedures.



11. Return the disk drive to the customer.

TST 2022                      PATHFINDER LEVEL II                      TST 2022

**CPU 'MSSTAT' Input Register and Input Multiplexer Test**

You have arrived at this procedure from DIA 0025, step 8; DIA 0025 is still looping.

You are testing the CPU 'MSSTAT' input register and input multiplexer circuitry on the A1A07 PCA.

When there is a malfunction in these circuits error code '22' appears in the data display.

1. Place the service switch in the Off (down) position.
2. Remove and replace A1A7.
3. Place the FE local/norm switch in the norm position.
4. Place the service switch in the On (up) position.
5. Place the start/stop switch in the start position.
6. Is error code '22' present in the data display?

No            Yes → Go to Pathfinder Level III, INF 3025.



7. Is any other error code present in the data display?

No            Yes → Consult the error code guide matrix.



8. Place the Massbus enable/disable switch on A1A12 in the enable (up) position.
9. Perform subsystem verification tests.
10. Are there error indications presented?

No            Yes → Use conventional system trouble-shooting procedures.



11. Return the disk drive to the customer.

**CPU 'MSSTAT', 'SWSTAT' and 'INAT' Multiplexer Register Test**

You have arrived at this procedure from DIA 0025, step 8; DIA 0025 is still looping.

You are testing the CPU 'MSSTAT', 'SWSTAT' and 'INAT' multiplexer register circuitry on the A1A07 PCA.

When there is a malfunction in these circuits error code '23' appears in the data display.

1. Place the service switch in the Off (down) position.
2. Remove and replace A1A7.
3. Place the FE local/norm switch in the norm position.
4. Place the service switch in the On (up) position.
5. Place the start/stop switch in the start position.
6. Is error code '23' present in the data display?

No      Yes → Go to Pathfinder Level III, INF 3025.



7. Is any other error code present in the data display?

No      Yes → Consult the error code guide matrix.



8. Place the Massbus enable/disable switch on A1A12 in the enable (up) position.
9. Perform subsystem verification tests.
10. Are there error indications presented?

No      Yes → Use conventional system troubleshooting procedures.



11. Return the disk drive to the customer.

TST 2024

PATHFINDER LEVEL II

TST 2024

**CPU 'ERSTAT' Register and Output Multiplexer Test**

You have arrived at this procedure from DIA 0025, step 8; DIA 0025 is still looping.

You are testing the CPU 'ERSTAT' register and output multiplexer register circuitry on the A1A07 PCA.

When there is a malfunction in these circuits error code '24' appears in the data display.

1. Place the service switch in the Off (down) position.
2. Remove and replace A1A7.
3. Place the FE local/norm switch in the norm position.
4. Place the service switch in the On (up) position.
5. Place the start/stop switch in the start position.
6. Is error code '24' present in the data display?  
 No      Yes → Go to Pathfinder Level III, INF 3025.  
 ↓
7. Is any other error code present in the data display?  
 No      Yes → Consult the error code guide matrix.  
 ↓
8. Place the Massbus enable/disable switch on A1A12 in the enable (up) position.
9. Perform subsystem verification tests.
10. Are there error indications presented?  
 No      Yes → Use conventional system troubleshooting procedures.  
 ↓
11. Return the disk drive to the customer.

**CPU 'ERSTAT' Register Test**

You have arrived at this procedure from DIA 0025, step 8; DIA 0025 is still looping.

You are testing the CPU 'ERSTAT' register.

When there is a malfunction in these circuits error code '25' appears in the data display.

1. Place the service switch in the Off (down) position.
2. Remove and replace A1A7.
3. Place the FE local/norm switch in the norm position.
4. Place the service switch in the On (up) position.
5. Place the start/stop switch in the start position.
6. Is error code '25' present in the data display?

No      Yes → Go to Pathfinder Level III, INF 3025.



7. Is any other error code present in the data display?

No      Yes → Consult the error code guide matrix.



8. Place the Massbus enable/disable switch on A1A12 in the enable (up) position.
9. Perform subsystem verification tests.
10. Are there error indications presented?

No      Yes → Use conventional system troubleshooting procedures.



11. Return the disk drive to the customer.

TST 2026                      PATHFINDER LEVEL II                      TST 2026

**CPU Mask Register and Output Multiplexer Addressing Test**

You have arrived at this procedure from DIA 0025, step 8; DIA 0025 is still looping.

You are testing the CPU mask register and output multiplexer addressing circuitry.

When there is a malfunction in these circuits error code '26' appears in the data display.

1. Place the service switch in the Off (down) position.
2. Remove and replace A1A7.
3. Place the FE local/norm switch in the norm position.
4. Place the service switch in the On (up) position.
5. Place the start/stop switch in the start position.
6. Is error code '26' present in the data display?

No            Yes → Go to Pathfinder Level III, INF 3025.



7. Is any other error code present in the data display?

No            Yes → Consult the error code guide matrix.



8. Place the Massbus enable/disable switch on A1A12 in the enable (up) position.
9. Perform subsystem verification tests.
10. Are there error indications presented?

No            Yes → Use conventional system troubleshooting procedures.



11. Return the disk drive to the customer.

**CPU 'MSSTAT' Output Register and Output Multiplexer Addressing Test**

You have arrived at this procedure from DIA 0025, step 8; DIA 0025 is still looping.

You are testing the CPU 'MSSTAT' output register and output multiplexer addressing circuitry on the A1A07 PCA.

When there is a malfunction in these circuits, error code '27' appears in the data display.

1. Set the oscilloscope controls to the following settings:

Volts/cm: 0.2V (X10 probe)  
 Time/cm: 5.0 microseconds  
 Trigger Slope: Normal  
 Trigger Source: CH 1 (+ slope)

2. Connect an insulated female scope probe from oscilloscope channel one to J070139 (+MSTATOUT Phase 4) and an insulated female jumper between oscilloscope ground and J070033.
3. Observe the oscilloscope presentation.

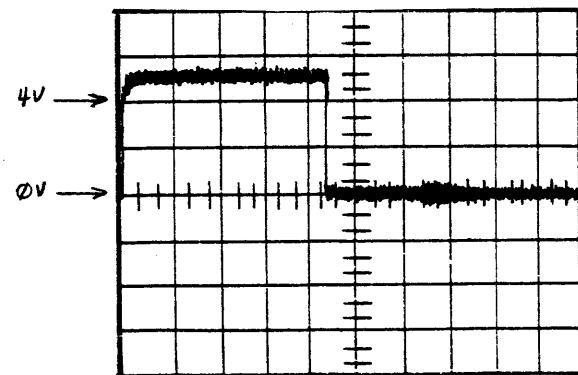

**NOTE**  
 You are looking to see that pulses are present.

4. Does the oscilloscope presentation look like the waveform illustrated above?

Yes      No → Place the service switch in the Off (down) position. Remove and replace A1A7. Go to step 56.

- 4A. Set the oscilloscope controls to the following settings:

Volts/cm: 0.2V (X10 probe)  
 Time/cm: 1.0 msec  
 Trigger Slope: Automatic  
 Trigger Source: Normal

5. Connect an insulated female scope probe from oscilloscope channel one to J070118 (-activate servo) and an insulated female jumper between oscilloscope ground and J070127.
6. Observe the oscilloscope presentation.

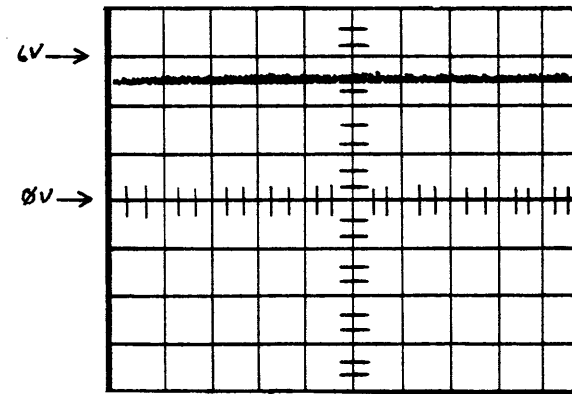

**NOTE**  
 You are looking for a DC level of +2.5 to +5 volts.

7. Does the oscilloscope presentation look like the waveform illustrated above?

No      Yes → Go to step 19.

8. Place the service switch in the Off (down) position.
9. Unseat A1A5.

10. Place the service switch in the On (up) position and wait for 'CE' to appear in the program code display.

11. Enter 'FE' in the FE panel keyboard.

12. Depress the enter/step switch.

13. Enter '25'.

14. Depress the enter/step switch.

15. Enter '11'.

16. Depress the enter/step switch.

17. Is error code '27' present in the data display?

Yes      No → Place the service switch in the Off (down) position. Remove and replace A1A5. Go to step 56.

18. Go to step 30.

19. Connect an insulated female scope probe from oscilloscope channel one to J070106 (-motor on) and an insulated female jumper between oscilloscope ground and J070127.

20. Observe the oscilloscope presentation.

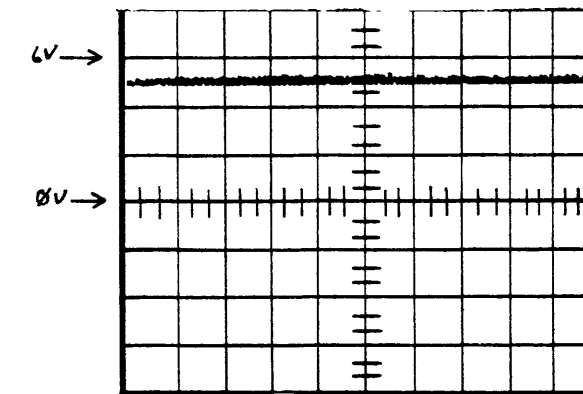

**NOTE**  
 You are looking for a DC of +2.5 to +5.0 volts.

21. Does the oscilloscope presentation look like the wave-form illustrated above?

Yes      No → Go to step 44.



22. Place the service switch to the Off (down) position.

23. Unseat A1A9.

24. Place the service switch in the On (up) position and wait about 30 seconds for 'CE' to appear in the program code display.

25. Perform steps 11 through 16 of this procedure and then return to step 26.

26. Is error code '27' present in the data display?

Yes      No → Place the service switch in the Off (down) position. Remove and replace A1A9. Go to step 56.



27. Place the service switch in the Off (down) position.

28. Reseat A1A9 and remove and replace A1A7.

29. Go to step 56.

30. Place the service switch in the Off (down) position.

31. Place CBI in the Off (down) position.

32. Unseat A1A2.

33. Place CBI in the On (up) position.

34. Insure that the oscilloscope is still connected to J070118.

35. Observe the oscilloscope presentation while placing the service switch in the On (up) position.

36. The oscilloscope signal should go from a low (0V) to a high (2.5 to 5.0V). The signal may return to a low (0V) again; if this is the case, it may be a quick transition, and the signal may look like a pulse or pulses.

**NOTE**

You may want to flip the service switch off and on a few times to insure proper observation of the signal.

37. Did the signal act as described?

Yes      No → Place the service switch in the Off (down) position and then place CBI in the Off (down) position. Reseat A1A2 and A1A5. Remove and replace A1A7 and go to step 56.



38. Place the service switch in the Off (down) position.

39. Place CBI in the Off (down) position.

40. Reseat A1A5.

41. Remove and replace A1A2.

42. Place CBI in the On (up) position.

43. Go to step 56.

44. Place the service switch in the Off (down) position.

45. Place CBI in the Off (down) position.

46. Unseat A1A2.

47. Place CBI in the On (up) position.

48. Insure that the oscilloscope is still connected to J070106.

49. Observe the oscilloscope presentation while placing the service switch in the On (up) position.

50. The oscilloscope signal should go from a low (0V) to a high (+2.5 to +5.0V). The signal may return to a low (0V) again; if this is the case, it may be a quick transition, and the signal may look like a pulse or pulses.

**NOTE**

You may want to flip the service switch off and on a few times to insure proper observation of the signal.

51. Did the signal act as described?

Yes      No → Place the service switch in the Off (down) position and then place CBI in the Off (down) position. Reseat A1A2. Remove and replace A1A7 and go to step 56.



52. Place the service switch in the Off (down) position.

53. Place CBI in the Off (down) position.

54. Remove and replace A1A2.

55. Place CBI in the On (up) position.

56. Place the FE local/norm switch in the norm position.

57. Place the service switch in the On (up) position.

58. Place the start/stop switch in the start position.

59. Is error code '27' present in the data display?

No      Yes → Go to Pathfinder Level III, INF 3025.

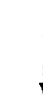

60. Is any other error code present in the data display?

No      Yes → Consult the error code guide matrix.



61. Place the Massbus enable/disable switch on A1A12 in the enable (up) position.

62. Perform subsystem verification tests.

63. Are there error indications presented?

No      Yes → Use conventional system troubleshooting procedures.

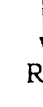

64. Return the disk drive to the customer.



**D/A-A/D Test (POS Offset)**

You have arrived at this procedure from DIA 002C, step 9; DIA 002C is still looping.

You are testing the D/A-A/D wrap back.

When there is a malfunction in these circuits, error code '28' appears in the data display.

1. Go to step 2.
2. Place the service switch in the Off (down) position.
3. Unseat A1A6.
4. Place the service switch in the On (up) position and wait for 'CE' to appear in the program code display.
5. Enter 'FE' in the FE panel keyboard.
6. Depress enter/step switch.
7. Enter '2C'.
8. Depress the enter/step switch.
9. Enter '11'.
10. Depress the enter/step switch.
11. Is error code '28' present in the data displays?

|    |       |  |
|----|-------|--|
| No | Yes → | Place the service switch in the Off (down) position. Reseat A1A6 and remove and replace A1A4. Go to step 14. |
| ↓  |       |  |

12. Place the service switch in the Off (down) position.
13. Remove and replace A1A6.
14. Place the FE local/norm switch in the norm position.
15. Place the service switch in the On (up) position.
16. Place the start/stop switch in the start position.

17. Is error code '28' present in the data display?

|    |       |                                       |
|----|-------|---------------------------------------|
| No | Yes → | Go to Pathfinder Level III, INF 302C. |
| ↓  |       |                                       |

18. Is any other error code present in the data display?

|    |       |                                      |
|----|-------|--------------------------------------|
| No | Yes → | Consult the error code guide matrix. |
| ↓  |       |                                      |

19. Place the Massbus enable/disable switch on A1A12 in the enable (up) position.

20. Perform subsystem verification tests.

21. Are there error indications presented?

|    |       |   |
|----|-------|---|
| No | Yes → | Use conventional system troubleshooting procedures. |
| ↓  |       |   |

22. Return the disk drive to the customer.

TST 2029

PATHFINDER LEVEL II

TST 2029

**D/A-A/D Test (Curve D/A Reference)**

You have arrived at this procedure from DIA 002C, step 9; DIA 002C is still looping.

You are testing the D/A-A/D (curve D/A reference) circuitry.

When there is a malfunction in these circuits, error code '29' appears in the data display.

1. Go to step 2.
2. Place the service switch in the Off (down) position.
3. Unseat A1A5.
4. Place the service switch in the On (up) position and wait for 'CE' to appear in the program code display.
5. Enter 'FE' in the FE panel keyboard.
6. Depress enter/step switch.
7. Enter '2C'.
8. Depress the enter/step switch.
9. Enter '11'.
10. Depress the enter/step switch.
11. Is error code '29' present in the data display?

No      Yes → Place the service switch in the Off (down) position. Remove and replace A1A5. Go to step 15.

↓

12. Place the service switch in the Off (down) position.
13. Reseat A1A5.
14. Remove and replace A1A4.
15. Place the FE local/norm switch in the norm position.
16. Place the service switch in the On (up) position.
17. Place the start/stop switch in the start position.

18. Is error code '29' present in the data display?

No      Yes → Go to Pathfinder Level III, INF 302C.

↓

19. Is any other error code present in the data display?

No      Yes → Consult the error code guide matrix.

↓

20. Place the Massbus enable/disable switch on A1A12 in the enable (up) position.

21. Perform subsystem verification tests.

22. Are there error indications presented?

No      Yes → Use conventional system troubleshooting procedures.

↓

23. Return the disk drive to the customer.

**Diff POS Greater Than -4.5V (Test Osc Even Defeat)**

You have arrived at this procedure from DIA 0031, step 9; DIA 0031 is still looping.

You are testing the diff POS greater than -4.5V (test osc even defeat) circuitry.

When there is a malfunction in these circuits, error code '2A' appears in the data display.

1. Set the oscilloscope controls to the following settings:

|                 |                  |
|-----------------|------------------|
| Volts/cm:       | 0.5V (X10 probe) |
| Time/cm:        | 5 msec           |
| Trigger Slope:  | Normal           |
| Trigger Source: | CH 1 (- slope)   |

2. Connect an insulated female scope probe to pin J040101 and an insulated female jumper from scope ground to pin J040033.
3. Observe the oscilloscope presentation.

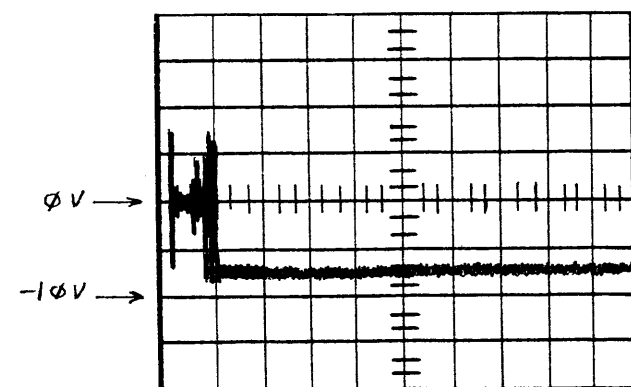
**NOTE**

You are looking for a transition from 0 to -8.0V (disregard noise).

4. Does the oscilloscope presentation look like the waveform illustrated above?

No      Yes → Turn the service switch Off. Remove and replace A1A4. Go to step 7.



5. Place the service switch in the Off (down) position.
6. Remove and replace A1A6.
7. Place the FE local/norm switch in the norm position.
8. Place the service switch in the On (up) position.
9. Place the start/stop switch in the start position.
10. Is error code '2A' present in the data display?

No      Yes → Go to Pathfinder Level III, INF 3031.



11. Is any other error code present in the data display?

No      Yes → Consult the error code guide matrix.



12. Place the Massbus enable/disable switch on A1A12 in the enable (up) position.
13. Perform subsystem verification tests.
14. Are there error indications presented?

No      Yes → Use conventional system troubleshooting procedures.



15. Return the disk drive to the customer.

TST 202B

PATHFINDER LEVEL II

TST 202B

**Position Signal Test**

You have arrived at this procedure from DIA 0031, step 9; DIA 0031 is still looping.

You are testing that the position less than +4.5V (test osc even defeat) circuitry.

When there is a malfunction in these circuits, error code '2B' appears in the data display.

1. Set the oscilloscope controls to the following settings:

|                 |                 |
|-----------------|-----------------|
| Volts/cm:       | .1V (X10 probe) |
| Time/cm:        | 10 msec         |
| Trigger Mode:   | Normal          |
| Trigger Source: | CH 1 (+ slope)  |

2. Connect an insulated female scope probe to pin J040102 and an insulated female jumper from scope ground to pin J040033.
3. Observe the oscilloscope presentation.

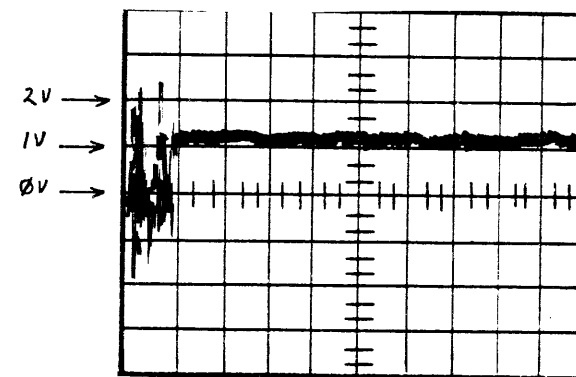
**NOTE**

You are looking for slightly positive signal (1.0 to 2.0 volts). Disregard the noise at the beginning of the trace.

4. Does the oscilloscope presentation look like the waveform illustrated above?

No      Yes → Place the service switch in the Off (down) position. Remove and replace A1A4. Go to step 7.

5. Place the service switch in the Off (down) position.
6. Remove and replace A1A5.
7. Place the FE local/norm switch in the norm position.
8. Place the service switch in the On (up) position.
9. Place the start/stop switch in the start position.
10. Is error code '2B' present in the data display?

No      Yes → Go to Pathfinder Level III, INF 3031.

11. Is any other error code present in the data display?

No      Yes → Consult the error code guide matrix.

12. Place the Massbus enable/disable switch on A1A12 in the enable (up) position.
13. Perform subsystem verification tests.
14. Are there error indications presented?

No      Yes → Use conventional system troubleshooting procedures.

15. Return the disk drive to the customer.

**Filtered Diff POS within the +0.5V Window (Test Osc Even Defeat)**

You have arrived at this procedure from DIA 0031, step 9; DIA 0031 is still looping.

You are testing that the filtered difference position is within the +0.5V window (test osc even defeat).

When there is a malfunction in these circuits, error code '2C' appears in the data display.

1. Set the oscilloscope controls to the following settings:

|                 |                 |
|-----------------|-----------------|
| Volts/cm:       | .1V (X10 probe) |
| Time/cm:        | 50 msec         |
| Trigger Mode:   | Automatic       |
| Trigger Source: | CH 1 (+ slope)  |

2. Connect an insulated female scope probe to pin J060129 and an insulated female jumper from scope ground to pin J060033.
3. Observe the oscilloscope presentation.

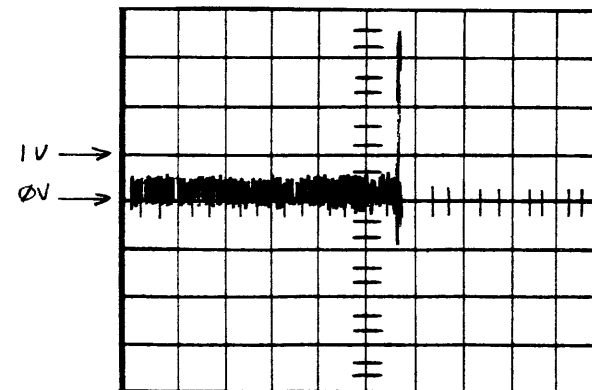
**NOTE**

You are looking for a DC level of from 0 to +0.5 volts in the first half of the trace (disregard pulses).

4. Does the oscilloscope presentation look like the waveform illustrated above?
  - No ↓
  - Yes → Turn the service switch in the Off position. Remove and replace A1A4. Go to step 7.

5. Place the service switch in the Off (down) position.
6. Remove and replace A1A6.
7. Place the FE local/norm switch in the norm position.
8. Place the service switch in the On (up) position.
9. Place the start/stop switch in the start position.
10. Is error code '2C' present in the data display?
  - No ↓
  - Yes → Go to Pathfinder Level III, INF 3031.

11. Is any other error code present in the data display?
  - No ↓
  - Yes → Consult the error code guide matrix.

12. Place the Massbus enable/disable switch on A1A12 in the enable (up) position.
13. Perform subsystem verification tests.
14. Are there error indications presented?
  - No ↓
  - Yes → Use conventional system troubleshooting procedures.

15. Return the disk drive to the customer.

## TST 202D                      PATHFINDER LEVEL II                      TST 202D

**Filtered Diff POS within the -0.5V Window (Test Osc On Track)**

You have arrived at this procedure from DIA 0031, step 9; DIA 0031 is still looping.

You are testing that the filtered difference position is within the -0.5V window.

When there is a malfunction in these circuits, error code '2D' appears in the data display.

1. Set the oscilloscope controls to the following settings:

|                 |                 |
|-----------------|-----------------|
| Volts/cm:       | .1V (X10 probe) |
| Time/cm:        | 50 msec         |
| Trigger Mode:   | Normal          |
| Trigger Source: | CH 1 (+ slope)  |

2. Connect an insulated female scope probe to pin J060129 and an insulated female jumper from scope ground to pin J060033.
3. Observe the oscilloscope presentation.

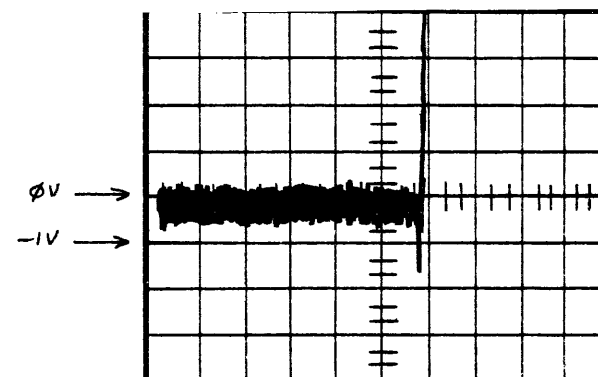
**NOTE**

You are looking for a DC level of from 0 to -0.5V in the first half of the trace (disregard pulses).

4. Does the oscilloscope presentation look like the waveform illustrated above?

No                      Yes → Place the service switch in the Off (down) position. Remove and replace A1A4. Go to step 7.



5. Place the service switch in the Off (down) position.
6. Remove and replace A1A6.
7. Place the FE local/norm switch in the norm position.
8. Place the service switch in the On (up) position.
9. Place the start/stop switch in the start position.
10. Is error code '2D' present in the data display?

No                      Yes → Go to Pathfinder Level III, INF 3031.



11. Is any other error code present in the data display?

No                      Yes → Consult the error code guide matrix.



12. Place the Massbus enable/disable switch on A1A12 in the enable (up) position.
13. Perform subsystem verification tests.
14. Are there error indications presented?

No                      Yes → Use conventional system troubleshooting procedures.



15. Return the disk drive to the customer.

**Filtered Diff POS within +0.5V Window (Test Osc On Track)**

You have arrived at this procedure from DIA 0031, step 9; DIA 0031 is still looping.

You are testing that the filtered difference position is within the +0.5V window (test osc on track).

When there is a malfunction in these circuits, error code '2E' appears in the data display.

1. Set the oscilloscope controls to the following settings:

|                 |                 |
|-----------------|-----------------|
| Volts/cm:       | .1V (X10 probe) |
| Time/cm:        | 50 msec         |
| Trigger Mode:   | Normal          |
| Trigger Source: | CH 1 (- slope)  |

2. Connect an insulated female scope probe to pin J040102 and an insulated female jumper from scope ground to pin J040033.
3. Observe the oscilloscope presentation.

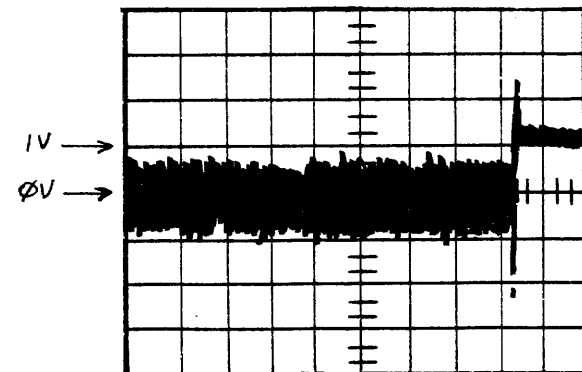
**NOTE**

You are looking for a DC level of from 0 to 0.5 volts of the grassy portion of the waveform (disregard pulses).

4. Does the oscilloscope presentation look like the waveform illustrated above?
  - No
  - Yes → Place the service switch in the Off (down) position. Remove and replace A1A4. Go to step 7.

5. Place the service switch in the Off (down) position.

6. Remove and replace A1A5.

7. Place the FE local/norm switch in the norm position.

8. Place the service switch in the On (up) position.

9. Place the start/stop switch in the start position.

10. Is error code '2E' present in the data display?
  - No
  - Yes → Go to Pathfinder Level III, INF 3031.

11. Is any other error code present in the data display?
  - No
  - Yes → Consult the error code guide matrix.

12. Place the Massbus enable/disable switch on A1A12 in the enable (up) position.

13. Perform subsystem verification tests.

14. Are there error indications presented?
  - No
  - Yes → Use conventional system troubleshooting procedures.

15. Return the disk drive to the customer.

**CROM Test - 0000 to 01FF**

You have arrived at this procedure from DIA 0035, step 8; DIA 0035 is still looping.

You are testing the first .5K of CROM to see that the generated check sums are correct.

When there is a malfunction in these circuits, error code '30' appears in the data display.

1. Go to step 2.
2. Place the service switch in the Off (down) position.
3. Unseat A1A10.
4. Place the service switch in the On (up) position and wait for 'CE' to appear in the program code display.
5. Enter 'FE' in the FE panel keyboard.
6. Depress enter/step switch.
7. Enter '35'.
8. Depress the enter/step switch.
9. Enter '11'.
10. Depress the enter/step switch.
11. Is error code '30' present in the data display?
 

|    |       |   |
|----|-------|---|
| No | Yes → | Place the service switch in the Off (down) position. Reseat A1A10 and remove and replace A1A9. Go to step 14. |
| ↓  |       |   |
12. Place the service switch in the Off (down) position.
13. Remove and replace A1A10.
14. Place the FE local/norm switch in the norm position.
15. Place the service switch in the On (up) position.
16. Place the start/stop switch in the start position and wait for the stack to spin or for '09' to appear in the program code display.

17. Is error code '30' present in the data display?
 

|    |       |                                       |
|----|-------|---------------------------------------|
| No | Yes → | Go to Pathfinder Level III, INF 3035. |
| ↓  |       |                                       |
18. Is any other error code present in the data display?
 

|    |       |                                      |
|----|-------|--------------------------------------|
| No | Yes → | Consult the error code guide matrix. |
| ↓  |       |                                      |
19. Place the Massbus enable/disable switch on A1A12 in the enable (up) position.
20. Perform subsystem verification tests.
21. Are there error indications presented?
 

|    |       |  |
|----|-------|--|
| No | Yes → | Use conventional system trouble-shooting procedures. |
| ↓  |       |  |
22. Return the disk drive to the customer.



TST 2031

PATHFINDER LEVEL II

TST 2031

**CROM Test - 0200 to 03FF**

You have arrived at this procedure from DIA 0035, step 8; DIA 0035 is still looping.

You are testing the second .5K of CROM to see that the generated check sums are correct.

When there is a malfunction in these circuits, error code '31' appears in the data display.

1. Go to step 2.
2. Place the service switch in the Off (down) position.
3. Remove and replace A1A10.
4. Place the FE local/norm switch in the norm position.
5. Place the service switch in the On (up) position.
6. Place the start/stop switch in the start position and wait for the stack to spin or for '09' to appear in the program code display.

7. Is error code '31' present in the data displays?

No      Yes → Go to Pathfinder Level III, INF 3035.



8. Is any other error code present in the data display?

No      Yes → Consult the error code guide matrix.



9. Place the Massbus enable/disable switch on A1A12 in the enable (up) position.

10. Perform subsystem verification tests.

11. Are there error indications presented?

No      Yes → Use conventional system troubleshooting procedures.



12. Return the disk drive to the customer.

**CROM Test - 0400 to 05FF**

You have arrived at this procedure from DIA 0035, step 8; DIA 0035 is still looping.

You are testing the third .5K of CROM to see that the generated check sums are correct.

When there is a malfunction in these circuits, error code '32' appears in the data display.

1. Go to step 2.
2. Place the service switch in the Off (down) position.
3. Remove and replace A1A10.
4. Place the FE local/norm switch in the norm position.
5. Place the service switch in the On (up) position.
6. Place the start/stop switch in the start position and wait for the stack to spin or for '09' to appear in the program code display.
7. Is error code '32' present in the data displays?  
No      Yes → Go to Pathfinder Level III, INF 3035.  
↓
8. Is any other error code present in the data display?  
No      Yes → Consult the error code guide matrix.  
↓
9. Place the Massbus enable/disable switch on A1A12 in the enable (up) position.
10. Perform subsystem verification tests.
11. Are there error indications presented?  
No      Yes → Use conventional system trouble-shooting procedures.  
↓
12. Return the disk drive to the customer.

TST 2033

PATHFINDER LEVEL II

TST 2033

**CROM Test - 0600 to 07FF**

You have arrived at this procedure from DIA 0035, step 8; DIA 0035 is still looping.

You are testing the fourth .5K of CROM to see that the generated check sums are correct.

When there is a malfunction in these circuits, error code '33' appears in the data display.

1. Depress the reset button on the FE control panel.
2. Enter '23' in the FE panel keyboard.
3. Depress the enter/step switch.

**NOTE**

Step 6 enters parameters. A delay between the diagnostic cycles (value entered X 128 microseconds) may be entered. This delay increases the time between loops. For single cycle execution of the diagnostic test enter 'FF'. The cycle may be repeated by depressing the enter/step switch.

4. Enter parameter 'FF'.
5. Depress the enter/step switch.

**NOTE**

If a CROM parity error does not occur, the program code display will momentarily display 'C0' and then display 'CF'. '00' will appear in the data display.

If a CROM parity error does occur, the address of the parity error will be displayed in the following manner:

High order byte - program code display.

Low order byte - data display.

The address range of the CROM is from 0000 to 0DFF.

6. Observe the program code display and the data display.
7. Is a CROM address present in the program display and the data display?

No      Yes → Record the CROM address and go to TST 208F.



8. Place the service switch in the Off (down) position.
9. Remove and replace A1A10.
10. Place the FE local/norm switch in norm position.
11. Allow the drive to cycle up. Is there an error code displayed in the data display?

No      Yes → Consult the error code guide matrix.



12. Place the Massbus enable/disable switch on A1A12 in the enable (up) position.
13. Perform subsystem verification tests.
14. Are there error indications presented?

No      Yes → Use conventional system troubleshooting procedures.



15. Return the disk drive to the customer.

**CROM Test - 0800 to 09FF**

You have arrived at this procedure from DIA 0035, step 8; DIA 0035 is still looping.

You are testing the fifth .5K of CROM to see that the generated check sums are correct.

When there is a malfunction in these circuits, error code '34' appears in the data display.

1. Go to step 2.
2. Place the service switch in the Off (down) position.
3. Remove and replace A1A10.
4. Place the FE local/norm switch in the norm position.
5. Place the service switch in the On (up) position.
6. Place the start/stop switch in the start position and wait for the stack to spin or for '09' to appear in the program code display.
7. Is error code '34' present in the data displays?

No      Yes → Go to Pathfinder Level III, INF 3035.



8. Is any other error code present in the data display?

No      Yes → Consult the error code guide matrix.



9. Place the Massbus enable/disable switch on A1A12 in the enable (up) position.
10. Perform subsystem verification tests.
11. Are there error indications presented?

No      Yes → Use conventional system troubleshooting procedures.



12. Return the disk drive to the customer.

TST 2035

PATHFINDER LEVEL II

TST 2035

**CROM Test - 0A00 to 0BFF**

You have arrived at this procedure from DIA 0035, step 8; DIA 0035 is still looping.

You are testing the sixth .5K of CROM to see that the generated check sums are correct.

When there is a malfunction in these circuits, error code '35' appears in the data display.

1. Go to step 2.
2. Place the service switch in the Off (down) position.
3. Remove and replace A1A10.
4. Place the FE local/norm switch in the norm position.
5. Place the service switch in the On (up) position.
6. Place the start/stop switch in the start position and wait for the stack to spin or for '09' to appear in the program code display.
7. Is error code '35' present in the data displays?

No      Yes → Go to Pathfinder Level III, INF 3035.



8. Is any other error code present in the data display?

No      Yes → Consult the error code guide matrix.



9. Place the Massbus enable/disable switch on A1A12 in the enable (up) position.

10. Perform subsystem verification tests.

11. Are there error indications presented?

No      Yes → Use conventional system troubleshooting procedures.



12. Return the disk drive to the customer.

**CROM Test - 0C00 to 0DFF**

You have arrived at this procedure from DIA 0035, step 8; DIA 0035 is still looping.

You are testing the seventh .5K of CROM to see that the generated check sums are correct.

When there is a malfunction in these circuits, error code '36' appears in the data display.

1. Go to step 2.
2. Place the service switch in the Off (down) position.
3. Remove and replace A1A10.
4. Place the FE local/norm switch in the norm position.
5. Place the service switch in the On (up) position.
6. Place the start/stop switch in the start position and wait for the stack to spin or for '09' to appear in the program code display.
7. Is error code '36' present in the data displays?

No      Yes → Go to Pathfinder Level III, INF 3035.



8. Is any other error code present in the data display?

No      Yes → Consult the error code guide matrix.



9. Place the Massbus enable/disable switch on A1A12 in the enable (up) position.

10. Perform subsystem verification tests.

11. Are there error indications presented?

No      Yes → Use conventional system trouble-shooting procedures.



12. Return the disk drive to the customer.

## TST 203C                      PATHFINDER LEVEL II                      TST 203C

**CPU Unsafe (No Interrupt) Test**

You have arrived at this procedure from DIA 0027, step 8.

You are testing the CPU Unsafe (No Interrupt) circuitry on the A1A07 PCA.

When there is a malfunction in these circuits error code '3C' appears in the data display.

1. Place the service switch in the Off (down) position.
2. Remove and replace A1A7.
3. Place the FE local/norm switch in the norm position.
4. Place the service switch in the On (up) position.
5. Place the start/stop switch in the start position.
6. Is error code '3C' present in the data display?  
     No        Yes → Go to Pathfinder Level III, INF 3027.  
     ↓
7. Is any other error code present in the data display?  
     No        Yes → Consult the error code guide matrix.  
     ↓
8. Place the Massbus enable/disable switch on A1A12 in the enable (up) position.
9. Perform subsystem verification tests.
10. Are there error indications presented?  
     No        Yes → Use conventional system trouble-shooting procedures.  
     ↓
11. Return the disk drive to the customer.

**CPU Unsafe (Interrupt Too Soon) Test**

You have arrived at this procedure from DIA 0027, step 8; DIA 0027 is still looping.

You are testing the CPU unsafe (interrupt too soon) circuitry on the A1A07 PCA.

When there is a malfunction in these circuits error code '3D' appears in the data display.

1. Place the service switch in the Off (down) position.
2. Remove and replace A1A7.
3. Place the FE local/norm switch in the norm position.
4. Place the service switch in the On (up) position.
5. Place the start/stop switch in the start position.
6. Is error code '3D' present in the data display?

No      Yes → Go to Pathfinder Level III, INF 3027.



7. Is any other error code present in the data display?

No      Yes → Consult the error code guide matrix.



8. Place the Massbus enable/disable switch on A1A12 in the enable (up) position.
9. Perform subsystem verification tests.
10. Are there error indications presented?

No      Yes → Use conventional system troubleshooting procedures.



11. Return the disk drive to the customer.



TST 203E

PATHFINDER LEVEL II

TST 203E

**Interrupt Test Failure**

You have arrived at this procedure from DIA 0026, step 8; DIA 0026 is still looping.

You are testing the interrupt test failure circuitry on the A1A07 PCA.

When there is a malfunction in these circuits error code '3E' appears in the data display.

1. Place the service switch in the Off (down) position.
2. Remove and replace A1A7.
3. Place the FE local/norm switch in the norm position.
4. Place the service switch in the On (up) position.
5. Place the start/stop switch in the start position.
6. Is error code '3E' present in the data display?  
 No      Yes → Go to Pathfinder Level III, INF 3026.  
 ↓
7. Is any other error code present in the data display?  
 No      Yes → Consult the error code guide matrix.  
 ↓
8. Place the Massbus enable/disable switch on A1A12 in the enable (up) position.
9. Perform subsystem verification tests.
10. Are there error indications presented?  
 No      Yes → Use conventional system trouble-shooting procedures.  
 ↓
11. Return the disk drive to the customer.

**Drive CPU Unsafe Test**

You have arrived at this procedure from DIA 0001, step 6.

You are testing the drive CPU unsafe circuitry on the A1A07 PCA.

When there is a malfunction in these circuits error code '3F' appears in the data display.

1. Place the service switch in the Off (down) position.
2. Unseat A1A10.
- 2A. Place the service switch in the On (up) position and wait approximately 30 seconds.
- 2B. Is error code '3F' present in the data display?
 

|     |      |  |
|-----|------|--|
| Yes | No → | Place the service switch in the Off (down) position. Remove and replace A1A10. Go to step 4. |
|-----|------|--|
- 2C. Place the service switch in the Off (down) position.
- 2D. Unseat A1A7.
- 2E. Place the service switch in the On (up) position.
- 2F. Using a VOM measure A1A2007 with reference to A1A2031 (GND) for 2.5 to 5 volts. Is the measurement 2.5 volts to 5 volts?
 

|     |      |  |
|-----|------|--|
| Yes | No → | Place service switch in the Off (down) position and then place CB1 in the Off (down) position. Reseat A1A7 and remove and replace A1A2. Place CB1 in the On (up) position and go to step 3A. |
|-----|------|--|
- 2G. Place the service switch in the Off (down) position.
3. Remove and replace A1A7.
- 3A. Reseat A1A10.
4. Place the service switch in the On (up) position.
5. Place the start/stop switch in the start position.

6. Is error code '3F' present in the data display?
 

|    |       |                                       |
|----|-------|---------------------------------------|
| No | Yes → | Go to Pathfinder Level III, INF 303F. |
|----|-------|---------------------------------------|
7. Is any other error code present in the data display?
 

|    |       |                                      |
|----|-------|--------------------------------------|
| No | Yes → | Consult the error code guide matrix. |
|----|-------|--------------------------------------|
8. Place the Massbus enable/disable switch on A1A12 in the enable (up) position.
9. Perform subsystem verification tests.
10. Are there error indications presented?
 

|    |       |   |
|----|-------|---|
| No | Yes → | Use conventional system troubleshooting procedures. |
|----|-------|---|
11. Return the disk drive to the customer.

TST 2041 PATHFINDER LEVEL II TST 2041

**Airflow Test**

You have arrived at this procedure from DIA 0001, step 6 or from POS 0001, step 12B.

You are testing the airflow warning circuitry.

When there is a malfunction in these circuits, error code '41' appears in the data display.

1. Place the palm of the hand on top of the electronic gate matrix.

1A. Is any airflow present?

No Yes → Go to step 3.

2. Is there a jack labeled 'J3A' adjacent to J3 on the AC power distribution box?

Yes No → Go to TST 2041-01 in the update section of this manual.

- 2A. There are two jacks on the AC power distribution box that the blower may be plugged into, J3 and J3A.

If the blower is plugged into J3, go to step 2B.

If the blower is plugged into J3A, go to step 2E.

- 2B. Set the VOM to an AC scale of at least 150 volts and measure the following points on J3 of the AC power distribution box.

Pin 1 to Pin 2  
Pin 3 to Pin 2

**NOTE**  
The diagram below shows the pin locations on J3.

TOP

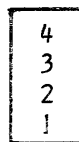

- 2C. Do both measurements equal 110 ±10 VAC?

No Yes → Place the service switch in the Off (down) position and then place CBI in the Off (down) position. Remove and replace the blower assembly. Place CBI in the On (up) position and go to step 17.

- 2D. Go to step 2G.

- 2E. Set the VOM to an AC scale of at least 250 volts and measure the following points on J3A of the power distribution box.

Pin 1 to Pin 3  
Pin 3 to Pin 5  
Pin 1 to Pin 5

**NOTE**  
The diagram below shows the pin locations on J3A.

TOP

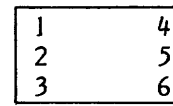

- 2F. Do all three measurements equal 200 to 240 VAC?

No Yes → Place the service switch in the Off (down) position and then place CBI in the Off (down) position. Remove and replace the blower assembly. Place CBI in the On (up) position and go to step 17.

- 2G. Check the AC input voltage at the wall (all three phases). Is it OK?

Yes No → Repair as required and go to step 17.

- 2H. Place CBI in the Off (down) position.

**CAUTION**

If any drives receive their AC input power through this drive (a cable connected to J2 of the power distribution box), all succeeding drives in the AC power daisy chain must be powered off before proceeding to step 2I.

- 2I. Unplug P1 through P5 from the power distribution box.

- 2J. Remove the power distribution box from the drive and remove the side access cover from the power distribution box.

- 2K. Check for continuity between the load and line terminals of the AC line filter. Is the filter OK?

Yes No → Remove and replace the AC line filter and go to step 2P.

- 2L. Place CBI in the On (up) position and check for continuity between the following terminals of CBI:

1 and 4  
2 and 5  
3 and 6

The diagram below shows the terminal locations on CBI.

Top of Distribution Box

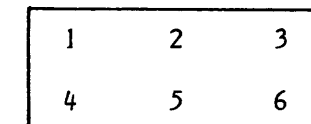

- 2M. Is CBI OK?

Yes No → Remove and replace CBI and go to step 2O (letter O).

- 2N. There is an open in the AC input power line within the power distribution box. Use an ohmmeter to find the problem and repair it. Then go to step 2O (letter O).

- 2O. Place CBI in the Off (down) position.

- 2P. Reinstall the side access cover onto the power distribution box and reinstall power distribution box into the drive.

**Airflow Test First Update**

You have arrived at this procedure from TST 2041, step 2 because the new type AC power distribution box is installed in your disk drive.

You are testing the airflow warning circuitry in general, and the AC input to the blower assembly in particular.

1. Set the VOM to an AC scale of at least 250 volts and measure the following points on J3 of the AC power distribution box.

Pin 1 to Pin 3  
Pin 3 to Pin 5  
Pin 1 to Pin 5

**NOTE**

The diagram below shows the pin locations on J3.

**TOP**

|   |   |
|---|---|
| 6 | 3 |
| 5 | 2 |
| 4 | 1 |

2. Do all three measurements equal 200 to 240 VAC?

No      Yes → Place the service switch in the Off (down) position and then place CB1 in the Off (down) position. Remove and replace the blower assembly. Place CB1 in the On (up) position. Go to TST 2041, step 17 in the Level II section of this manual.

3. Go to TST 2041, step 2G in the Level II section of this manual.

23. Are there error indications presented?

No      Yes → Use conventional system troubleshooting procedures.

24. Return the disk drive to the customer.

THIS PAGE INTENTIONALLY LEFT BLANK

2Q. Plug P1 through P5 back into the power distribution box. Succeeding drives in the AC input power daisy chain may now be powered up.

2R. Place CBI in the On (up) position.

2S. Go to step 17.

3. Check prefilter and absolute filter. Are they blocked?

No → Yes → Replace with new filter and go to step 17.

4. Go to step 5.

5. Set the oscilloscope controls to the following settings:

Volts/cm: .1V (X10 probe)  
 Time/cm: 50 msec  
 Trigger Mode: Automatic  
 Trigger Source: Normal

6. Connect an insulated female scope probe to pin J020079 and an insulated female jumper from scope ground to pin J020033.

7. Observe the oscilloscope presentation.

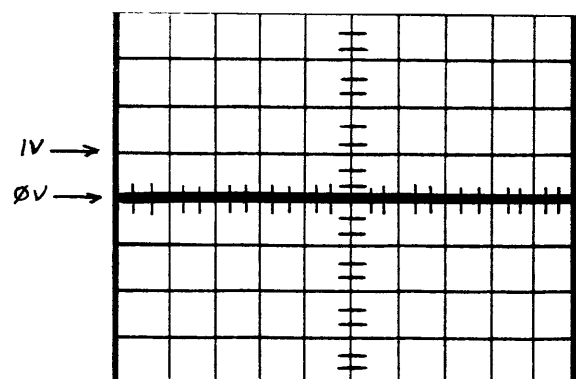

**NOTE**  
 You are looking for a DC level of approximately 0 volts and not a DC level of approximately 0.7 volts.

8. Does the oscilloscope presentation look like the waveform illustrated above?

Yes → No → Check air line for kinks or obstructions. If any, repair. Remove the air line from the absolute filter and while blowing into the hose, repeat step 7. Go to step 14.

9. Change the oscilloscope volts/cm control to 0.2V (X10 probe). Connect an insulated female scope probe to pin J020012 and an insulated female jumper between oscilloscope and ground and pin J020033.

Observe the oscilloscope presentation.

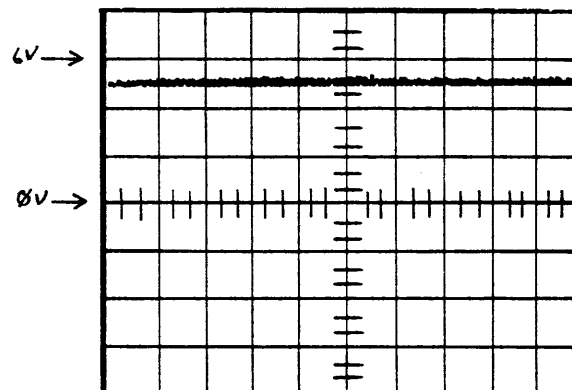

**NOTE**

You are looking for a DC level of approximately +2.5 to 5 volts.

10. Does the scope presentation look like the waveform illustrated above?

No → Yes → Place the service switch Off (down). Remove and replace A1A7. Go to step 17.

11. Place the service switch Off (down).

11A. Unseat A1A7.

11B. Place the service switch in the On (up) position.

11C. Does the oscilloscope presentation now look like the waveform illustrated in step 9?

No → Yes → Place the service switch in the Off (down) position. Remove and replace A1A7. Go to step 17.

11D. Place the service switch in the Off (down) position.

11D. Place CBI Off (down).

12. Reseat A1A7 and remove and replace A1A2.

12A. Place CBI On (up).

13. Go to step 17.

14. Does the oscilloscope presentation now look like the waveform illustrated in step 7?

Yes → No → Place the service switch in the Off (down) position. Remove and replace the air switch. Go to step 17.

15. Place the service switch in the Off (down) position.

16. Remove and replace absolute filter

17. Place the FE local/norm switch in the norm position.

17A. Place the service switch in the On (up) position.

18. Observe the data display. Is error code '41' present in the data display?

No → Yes → Go to Pathfinder Level III, INF 3041.

19. Place the start/stop switch in the start position.

20. Is any error code present in the data display?

No → Yes → Consult the error code guide matrix.

21. Place the Massbus enable/disable switch on A1A12 in the enable (up) position.

22. Perform subsystem verification tests.

**Pack Speed, PLO Unsafe 1 and Index Test**

You have arrived at this procedure from DIA 0001, step 6.

You are testing pack speed, PLO unsafe 1 and index circuitry.

When there is a malfunction in these circuits, error code '42' appears in the data display.

1. Place the start/stop switch in the stop position.
2. Place the FE local/norm switch in the FE local position and wait for 'CE' to appear in the program code display.
3. Enter 'FE' in the FE panel keyboard.
4. Depress enter/step switch.
5. Enter '3E'.
6. Depress the enter/step switch.
7. Enter the parameter '11'.
8. Depress the enter/step switch.
9. Visually inspect the stack motor. Is it spinning?  
 No      Yes → Go to step 28.  
 ↓
10. Go to step 11.
11. Set the oscilloscope controls to the following settings:  
 Volts/cm:            2V (X10 probe)  
 Time/cm:            1 msec  
 Trigger Mode:        Automatic  
 Trigger Source:      Normal
12. Connect an insulated female scope probe to pin J020060 (-48 motor relay) and an insulated female jumper from scope ground to pin J020033.

Observe the oscilloscope presentation.

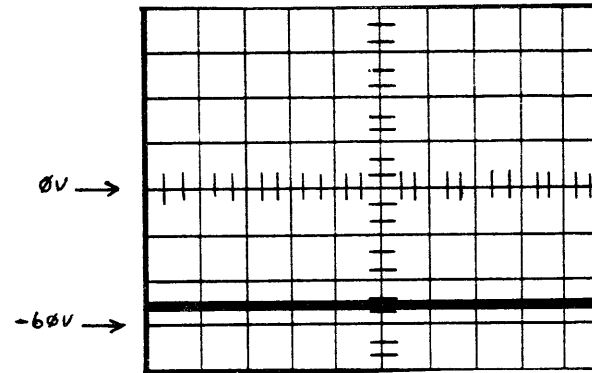

**NOTE**  
 You are looking for a DC level of approximately -48 volts.

13. Does the oscilloscope presentation look like the waveform illustrated above?  
 No      Yes → Go to step 72.  
 ↓
14. Set the oscilloscope controls to the following settings:  
 Volts/cm:            0.5V (X10 probe)  
 Time/cm:            1 msec
15. Connect an insulated female scope probe to pin J020026 (-motor on) and an insulated female jumper from scope ground to pin J020033.

16. Observe the oscilloscope presentation.

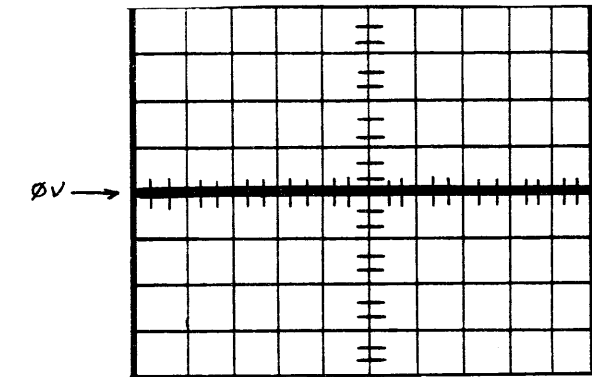

**NOTE**  
 You are looking for a low (ground) signal.

17. Does the oscilloscope presentation look like the waveform illustrated above?  
 Yes      No → Place the service switch in the Off (down) position and then place CBI in the Off (down) position. Remove and replace A1A7. Place the service switch in the On (up) position and go to step 143.  
 ↓
18. Set the oscilloscope controls to the following settings:  
 Volts/cm:            2.0V (X10 probe)  
 Time/cm:            1 msec  
 Trigger Mode:        Automatic  
 Trigger Source:      Normal
19. Connect an insulated female scope probe to pin J010117 (-48V) and an insulated female jumper from scope ground to pin J010100.

Observe the oscilloscope presentation.

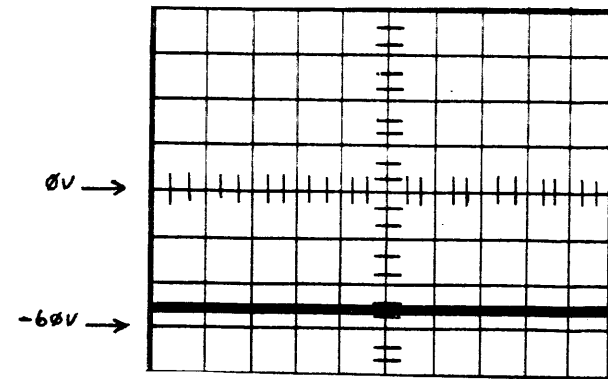

**NOTE**

You are looking for a DC level of approximately -48 volts.

20. Does the scope presentation look like the waveform illustrated above?

No Yes → Place CBI in the Off (down) position. Remove and replace A1A2. Place CBI in the On (up) position and go to step 143.

21. Using a VOM set on an AC scale to measure at least 50 volts, measure the voltage between A1A1P3004 and A1A1P3001.

**NOTE**

There are three plugs plugged into the bottom front of A1A1. P3 is the bottom plug. The diagram below shows the pin locations on P3.

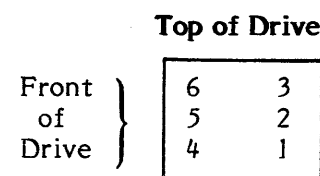

22. Was the voltage measured in step 21 at 48 ±4 VAC?

No Yes → Place the service switch in the Off (down) position and then place CBI in the Off (down) position. Remove and replace A1A1. Place CBI in the On (up) position and go to step 143.

23. Place the service switch in the Off (down) position.

24. Place CBI Off (down).

25. Remove and replace the AC input power transformer.

26. Place CBI in the On (up) position.

27. Go to step 143.

28. Visually inspect the stack pulley and belt to determine if the stack is spinning. Is it?

No Yes → Go to step 112.

29. Push the reset button on the FE control panel.

30. Enter '3F' in the FE panel keyboard.

31. Depress the enter/step switch.

32. Enter '111'.

33. Depress the enter/step switch.

34. Place the service switch in the Off (down) position.

35. Place CBI in the Off (down) position.

36. Is the belt broken?

No Yes → Remove and replace the belt and go to step 142.

37. Go to step 136.

**NOTE**

Steps 38 through 53 have been deleted.

54. Push the reset button on the FE control panel and then place CBI in the Off (down) position.

55. Unplug P1, P3 or P3A (whichever is used), P4 and P5 from the power distribution box.

56. Remove the power distribution box from the disk drive and remove and replace the '3 phase sensor detector' PCA.

57. Reinstall the side access cover on the power distribution box and reinstall power distribution box into the drive. Bolt in place.

58. Plug P1 through P5 back into the power distribution box (succeeding disk drives in the AC input power daisy chain may now be powered up).

59. Place CBI in the On (up) position and perform steps 2 through 8 of this procedure.

60. Did CB2 on the back of A1A1 move to the tripped (down) position?

No Yes → Go to Pathfinder Level III, INF 3042.

61. Go to step 143.

**NOTE**

Steps 62 through 71 have been deleted.

**NOTE**

For RP07 drives with 50 Hz wye configuration, power distribution voltage will be approximately 440 volts.

72. Set up a multimeter to measure an AC voltage of approximately 220 volts (50/60 Hz) or 440 volt (50 Hz wye) and measure the voltage from the following points on the power distribution box.

- P4, Pin 1 to P4, Pin 2
- P4, Pin 2 to P4, Pin 3
- P4, Pin 1 to P4, Pin 3

**NOTE**

The diagram below shows the pin locations for P4. P4 must remain plugged in while making measurement.



**Top of Power Distribution Box**

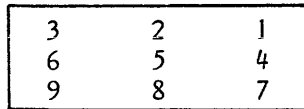

73. All three measurements should equal about 220 VAC (50/60 Hz) or 440 VAC (50 Hz wye)? Are they all OK?

No Yes → Place the service switch in the Off (down) position and then place CBI in the Off (down) position. Remove and replace the drive brake and motor assembly. Place CBI in the On (up) position and go to step 143.

74. Push the reset button on the FE control panel.

**CAUTION**

The following steps, 75 through 96, check out relay K1. During these steps hazardous voltages are exposed and extreme care should be exercised at all times.

75. Place CBI in the Off (down) position.

**CAUTION**

If any drives receive their AC input power through this drive (a cable connected to J2 of the power distribution box), all succeeding drives in the AC power daisy chain must be powered off before proceeding to step 76.

76. Unplug P1 through P5 from the power distribution box.

77. Remove the power distribution box from the drive and remove the side access cover from the power distribution box.

78. Slide the power distribution box partially back in place. The power distribution box should be left far enough out so that K1 (K1 is the large relay attached to the back of power distribution box with four (4) large copper terminals) is accessible, but far enough in so that P3, P4 and P5 can be plugged in.

**CAUTION**

After performing step 79 hazardous voltages will be present and exposed in the power distribution box.

79. Plug P1, P3 or P3A, P4 and P5 into the power distribution box and place CBI in the On (up) position.

80. Set up a multimeter to measure about 220 volts AC (50/60 Hz) or 440 volts AC (50 Hz wye).

81. Check for 220 VAC (50/60 Hz) or 440 VAC (50 Hz wye) from the following points:

P3, Pin 1 to K1 Pin 3 (top inside copper terminal)

P3, Pin 1 to K1 Pin 5 (top outside copper terminal)

**NOTE**

The diagram below shows the pin locations for P3.

**Top of Power Distribution Box**

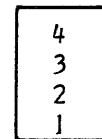

82. Did both measurements check OK?

Yes No → Place CBI in the Off (down) position. Remove the power distribution box from the drive and remove the side access cover. There is an opening in one of the AC lines within the power distribution box. Use an ohmmeter to find the problem and repair it. Go to step 57.

83. Perform steps 2 through 8 of this procedure.

84. Set up the multimeter to measure about 50 volts DC.

85. Check for 48 VDC from the following points:

K1, Pin 1 (negative) to K1, Pin 2 (positive)

**NOTE**

If performing Step 85 with the A2A2 relay PCA installed in the power distribution box, the 48 VDC check is made at the following points: Pin 3 (negative) to Pin 4 (positive) on the Terminal Block (TB1).

**NOTE**

Pins 1 and 2 are the two non-copper terminals on the lower portion of K1. Pin 1 is toward the outside and Pin 2 is toward the inside when viewed from the open side of the power distribution box.

86. Did the meter indicate approximately 48 ±4 volts?

Yes No → Go to step 92.

87. Push the reset button on the FE control panel.

88. Place CBI in the Off (down) position.

89. Unplug P1, P3 or P3A (whichever is used), P4 and P5 from the power distribution box.

90. Remove the power distribution box from the disk drive and remove and replace K1.

91. Go to step 57.

92. Check for 48 volts DC from the following points:

P7, Pin 2 (negative) to P7, Pin 3 (positive)

**NOTE**

P7 is one of the plugs that is plugged into the three phase sensor PCA. P7 is the one that is closest to the power distribution box access opening. The diagram below shows the pin locations on P7.

**Front of Power Distribution Box**

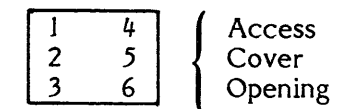

93. Did the meter indicate approximately 48 ±4 volts?

No Yes → Go to step 54.

94. Push the reset button on the FE control panel.
95. Place CBI in the Off (down) position.
96. Unplug P1, P3 or P3A (whichever is used), P4 and P5 from the power distribution box.
97. Remove the power distribution box from the disk drive and reinstall the side access cover removed in step 77.
98. Reinstall the power distribution box onto the disk drive and bolt in place.
99. Plug P1 through P4 into the power distribution box (succeeding disk drives in the AC input power daisy chain may now be powered up).
100. Disconnect P2 from A1A1.

**NOTE**  
There are three plugs plugged into the bottom front of all A1A1. P2 is the middle plug.

101. Set the multimeter to measure resistance on the RX1 scale.
102. Check for continuity between the following points (P5 is the plug that goes to the power distribution box):

P2, Pin 1 and P5, Pin 1  
P2, Pin 4 and P5, Pin 4

103. Do both lines measure approximately zero ohms?  
No Yes → Reconnect J2 to A1A1 and P5 to the power distribution box. Go to step 107.

104. Repair the harness if possible. If not possible, remove and replace the input transformer and harness assembly (A10).
105. Reconnect P2 to A1A1 and P5 to the power distribution box.
106. Place CBI in the On (up) position and go to step 143.
107. Remove A1A1.

108. Check for continuity on A1A1 between the following points: backplane connector pins 0043 and 0044, and J2, pin 1.

109. Does it check OK?  
No Yes → Reinsert A1A1 and go to Pathfinder Level III, INF 3042.

110. Replace A1A1 with a new part and plug P5 back into the power distribution box.
111. Place CBI in the On (up) position and go to step 143.
112. Set the oscilloscope controls to the following settings:

Volts/cm: 0.5V (X10 probe)  
Time/cm: 1 msec  
Trigger Mode: Automatic  
Trigger Source: Normal

113. Connect an insulated female scope probe to pin J060022 (-PLO unsafe) and an insulated female jumper from scope ground to pin J060033.

Observe the oscilloscope presentation.

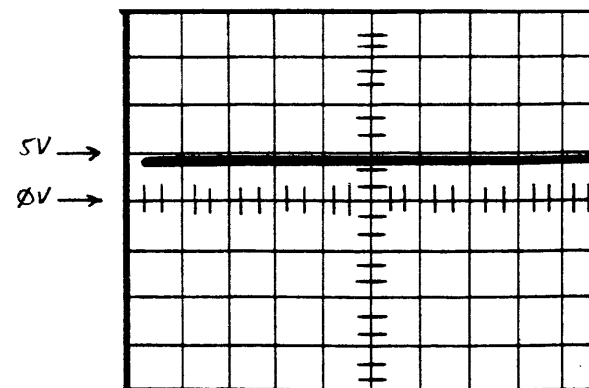

**NOTE**  
You are looking for a DC level of approximately +2.5 to +5.0 volts.

114. Does the oscilloscope presentation look like the waveform illustrated above?

No Yes → Go to step 131.

115. Is the drive belt broken?

No Yes → Perform steps 126 through 126D of this procedure. Place the service switch in the Off (down) position and then place CBI in the Off (down) position. Remove and replace the belt. Place CBI in the On (up) position and go to step 143.

- 115A. Is the belt tension spring broken or off its retainer mounting?

No Yes → Perform steps 126 through 126D of this procedure. Place the service switch in the Off (down) position and then place CBI in the Off (down) position. Reinstall the spring or remove and replace it as required. Place CBI in the On (up) position and go to step 143.

116. Set the oscilloscope controls to the following settings:

Volts/cm: 0.5V (X10 probe)  
Time/cm: 0.5 microseconds  
Trigger Mode: Normal  
Trigger Source: CH 1 (+ slope)

117. Connect an insulated female scope probe to pin J060079 (servo data) and an insulated female jumper from scope ground to pin J060033.

118. Observe the oscilloscope presentation.

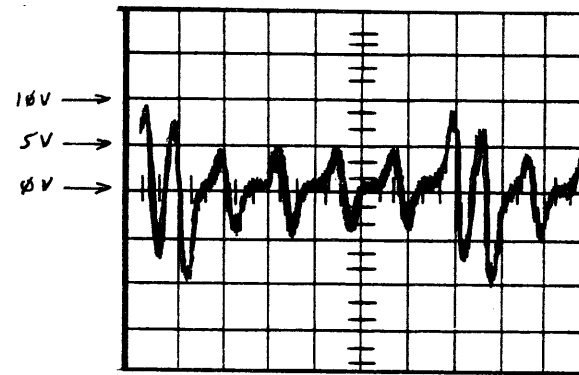

**NOTE**

You are looking for a peak to peak amplitude on the larger pulses of from 10 to 20 volts and that the general shape of the waveform is correct. Disregard any discrepancy in frequency at this time. The signal may jitter. Both smaller and larger pulses need to be present as shown above.

119. Does the oscilloscope presentation look like the waveform illustrated above?

No      Yes → Place the service switch in the Off (down) position and then place CBI in the Off (down) position. Go to step 136.

120. Set the oscilloscope controls to the following settings:

Volts/cm:            0.5V (X10 probe)  
 Time/cm:            1 msec  
 Trigger Mode:        Automatic  
 Trigger Source:     Normal

121. Connect an insulated female scope probe to pin J060156 (preamp-VCC) and an insulated female jumper from scope ground to pin J060033.

122. Observe the oscilloscope presentation.

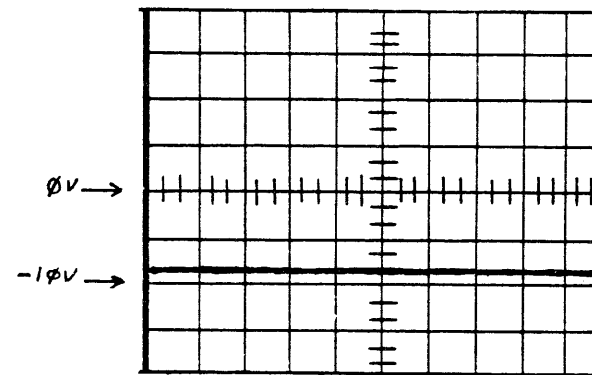

**NOTE**

You are looking for a DC level of approximately -8 volts.

123. Did the oscilloscope presentation look like the waveform illustrated above?

No      Yes → Perform steps 126 through 126D of this procedure. Place the service switch in the Off (down) position and then place CBI in the Off (down) position. Remove and replace the HDA. Place CBI in the On (up) position and go to step 143.

123A. Perform steps 126 through 126D of this procedure and then return to step 123B.

123B. Place the service switch in the Off (down) position and then place CBI in the Off (down) position.

124. Unplug the HDA.

124A. Place CBI in the On (up) position and then place the service switch in the On (up) position and wait for 'CE' to appear in the program code display.

124B. Perform steps 3 through 8 of this procedure.

125. Does the oscilloscope presentation look like the waveform in step 122?

No      Yes → Perform steps 126 through 126D of this procedure. Place the service switch in the Off (down) position and then place CBI in the Off (down) position. Remove and replace the HDA. Place CBI in the On (up) position and go to step 143.

126. Push the reset button on the FE control panel and hold down until 'FE' appears in the program code display.

126A. Enter '3F' in the FE panel keyboard.

126B. Depress enter/step switch.

126C. Enter '11'.

126D. Depress the enter/step switch and wait for the stack to stop spinning.

127. Place the service switch in the Off (down) position and place CBI in the Off (down) position.

128. Remove and replace A1A6 and plug in the HDA.

129. Place CBI in the On (up) position and place the service switch in the On (up) position.

130. Go to step 143.

131. Set the oscilloscope controls to the following settings:

Volts/cm:            0.2V (X10 probe)  
 Time/cm:            2 msec  
 Trigger Mode:        Automatic  
 Trigger Source:     CH 1  
 Trigger Slope:        Negative

132. Connect an insulated female scope probe to pin J060032 (-index) and an insulated female jumper from scope ground to pin J060033.

133. Observe the oscilloscope presentation.

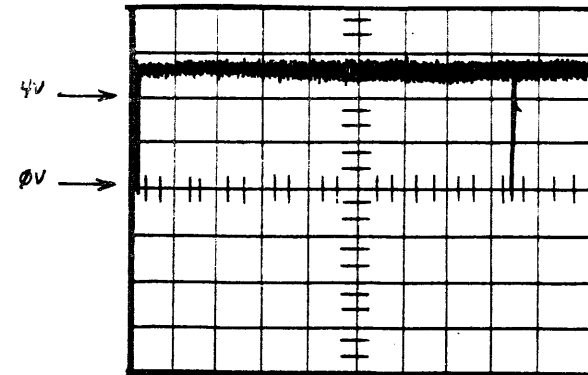

**NOTE**  
Pulses should be 16.7 msec +0.5 msec apart. The stack must be spinning. Timing is critical.

**NOTE**  
Index pulses are very difficult to see. Intensity must be turned up very bright in order to see the waveform.

134. Did the oscilloscope presentation look like the waveform illustrated above?

No  
Yes → Perform steps 126 through 126D of this procedure. Place the service switch in the Off (down) position. Remove and replace A1A7. Place the service switch in the On (up) position and go to step 143.

135. Push the reset button on the FE control panel and hold down until 'FE' appears in the program code display.

135A. Enter '3F' in the FE panel keyboard.

135B. Depress enter/step switch.

135C. Enter '11'.

135D. Depress the enter/step switch and wait for the stack to stop spinning.

135E. Place the service switch in the Off (down) position.

135F. Unseat A1A8.

135G. Place the service switch in the On (up) position and wait for 'CE' to appear in the program code display.

135H. Enter 'FE' in the FE panel keyboard.

135I. Depress enter/step switch.

135J. Enter '3E'.

135K. Depress the enter/step switch.

135L. Enter '11'.

135M. Depress the enter/step switch and wait for the stack to spin.

135N. Observe the oscilloscope presentation.

135O. Does the oscilloscope presentation look like the waveform illustrated in step 133?

No  
Yes → Perform steps 135 through 135D of this procedure. Place the service switch in the Off (down) position. Remove and replace A1A8. Place the service switch in the On (up) position and go to step 143.

135P. Perform steps 135 through 135D of this procedure. Place the service switch in the Off (down) position.

135Q. Place CBI in the Off (down) position.

135R. Reseat A1A8.

136. Can the belt be made to slip over the surface of the pulley by pulling on the belt?

No  
Yes → Go to step 140.

137. Is the brake defective? (This can be determined by a smell of burning rubber.)

No  
Yes → Remove and replace the motor and brake assembly. Place CBI in the On (up) position and go to step 143.

138. Remove and replace A1A6.

139. Place CBI in the On (up) position and go to step 143.

140. Is the belt tension spring broken or is it off of its mounting?

No  
Yes → Reinstall or remove and replace the spring as required. Place CBI in the On (up) position and go to step 143.

141. Remove and replace the belt.

142. Place CBI in the On (up) position.

143. Place the FE local/norm switch in the norm position

143A. Place the service switch in the On (up) position.

144. Place the start/stop switch in the start position.

145. Is error code '42' present in the data display?

No  
Yes → Go to Pathfinder Level III, INF 3042.

146. Is any other error code present in the data display?

No  
Yes → Consult the error code guide matrix.

147. Place the Massbus enable/disable switch on A1A12 in the enable (up) position.

148. Perform subsystem verification tests. Are there any error indications present?

No  
Yes → Use conventional system troubleshooting procedures.

149. Return the disk drive to the customer.

TST 2043                      PATHFINDER LEVEL II                      TST 2043

**PLO Unsafe I Test**

You have arrived at this procedure from DIA 0001, step 6.

You are testing the PLO Unsafe I circuitry.

When there is a malfunction in these circuits, error code '43' appears in the data display.

1. Depress the reset button on the FE panel.
2. Enter '11' in the FE panel keyboard.
3. Depress enter/step switch.
4. Enter '01'.
5. Depress the enter/step switch.
6. Enter '01' again.
7. Depress the enter/step switch.
8. Enter '00'.
9. Depress the enter/step switch.
10. You are now attempting to run continuous incremental seeks with one track increments. Let the routine run for a few minutes. When the routine stops with a '43' error, read RAM locations 1812 (high CAR) and 1811 (low CAR) to record the cylinder address (perform steps 18 through 24 of this procedure to read RAM locations 1811 and 1812). To restart the routine after reading RAM, repeat steps 1 through 9 of this procedure. If the routine always stops at the same cylinder, allow it to continue to determine if other cylinders will fail. This can be done by depressing the enter/step switch instead of reading RAM.
11. Did the '43' errors occur only on specific cylinders?  

|     |    |  |
|-----|----|--|
| Yes | No | → Place the start/stop switch in the stop position and then the service switch in the Off (down) position. Remove and replace A1A6. Go to step 25. |
| ↓   |    |  |
12. Place the start/stop switch in the stop position.
13. Place the service switch in the Off (down) position.

14. Place CB1 in the Off (down) position.
15. Remove and replace the HDA.
16. Place CB1 in the On (up) position.
17. Go to step 25.
18. Depress the reset button on the FE panel.
19. Enter '17' in the FE panel keyboard.
20. Depress the enter/step switch.
21. Enter '11'.
22. Depress the enter/step switch and record the low CAR byte present in the data display.
23. Depress the enter/step switch again and record the high CAR byte present in the data display.
24. Return to step 10.
25. Place the FE local/norm switch in the norm position.
26. Place the service switch in the On (up) position.
27. Place the start/stop switch in the start position and wait for the stack to spin or for an '09' to appear in the program code display.
28. Is error code '43' present in the data display?  

|    |     |   |
|----|-----|---|
| No | Yes | → Go to Pathfinder Level III, INF 3043. |
| ↓  |     |   |
29. Is any other error code present in the data display?  

|    |     |  |
|----|-----|--|
| No | Yes | → Consult the error code guide matrix. |
| ↓  |     |  |
30. Place the Massbus enable/disable switch on A1A12 in the enable (up) position.
31. Perform subsystem verification tests.

32. Are there error indications presented?  

|    |     |   |
|----|-----|---|
| No | Yes | → Use conventional system troubleshooting procedures. |
| ↓  |     |   |
33. Return the disk drive to the customer.

**Servo Error Offset Greater Than 0.5V**

You have arrived at this procedure from DIA 0032, step 8. DIA 0032 is still looping.

You are testing the servo error offset greater than 0.5V circuitry.

When there is a malfunction in these circuits, error code '48' appears in the data display.

1. Go to step 2.
2. Place the service switch in the Off (down) position.
3. Connect an insulated female jumper from J040103 to J040127.
4. Place the service switch in the On (up) position.
5. Place the FE local/norm switch in the norm position.
6. Place the start/stop switch in the start position.

7. Is error code '5F' present in the data display?

No      Yes → Place the start/stop switch in the stop position and the service switch in the Off (down) position. Remove and replace A1A5. Go to step 11.

↓

8. Place the start/stop switch in the stop position.
9. Place the service switch in the Off (down) position.
10. Remove and replace A1A4.
11. Remove the jumper installed in step 3.
12. Place the service switch in the On (up) position.
13. Place the start/stop switch in the start position.
14. Is error code '48' present in the data display?

No      Yes → Go to Pathfinder Level III, INF 3032.

↓

15. Is any other error code present in the data display?

No      Yes → Consult the error code guide matrix.

↓

16. Place the Massbus enable/disable switch on A1A12 in the enable (up) position.
17. Perform subsystem verification tests.
18. Are there error indications presented?

No      Yes → Use conventional system troubleshooting procedures.

↓

19. Return the disk drive to the customer.

**TST 2049                      PATHFINDER LEVEL II                      TST 2049**

**Servo Error Offset More Negative Than -0.5 Volts**

You have arrived at this procedure from DIA 0032, step 8. DIA 0032 is still looping.

You are testing the servo error offset more negative than -0.5V circuitry.

When there is a malfunction in these circuits, error code '49' appears in the data display.

1. Go to step 2.
2. Place the service switch in the Off (down) position.
3. Connect an insulated female jumper from J040103 to J040127.
4. Place the service switch in the On (up) position.
5. Place the FE local/norm switch in the norm position.
6. Place the start/stop switch in the start position.
7. Is error code '5F' present in the data display?

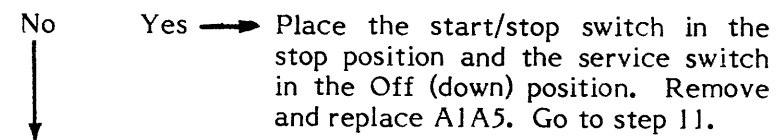

8. Place the start/stop switch in the stop position.
9. Place the service switch in the Off (down) position.
10. Remove and replace A1A4.
11. Remove the jumper installed in step 3.
12. Place the service switch in the On (up) position.
13. Place the start/stop switch in the start position.
14. Is error code '49' present in the data display?

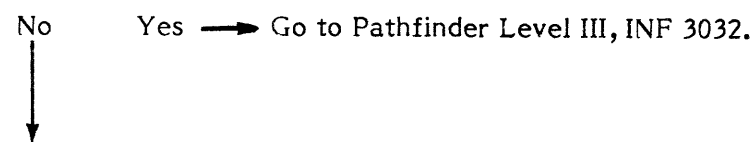

15. Is any other error code present in the data display?
 

|    |       |                                      |
|----|-------|--------------------------------------|
| No | Yes → | Consult the error code guide matrix. |
| ↓  |       |                                      |
16. Place the Massbus enable/disable switch on A1A12 in the enable (up) position.
17. Perform subsystem verification tests.
18. Are there error indications presented?
 

|    |       |   |
|----|-------|---|
| No | Yes → | Use conventional system troubleshooting procedures. |
| ↓  |       |   |
19. Return the disk drive to the customer.

**Analog B PCA Test**

You have arrived at this procedure from DIA 0019, step 8. DIA 0019 is still looping.

You are testing the pulser/driver PROM and its associated circuitry for no active outputs.

When there is a malfunction in these circuits, error code '4B' appears in the data display.

1. Depress the reset button on the FE panel.
2. Place the start/stop switch in the stop position.
3. Set the oscilloscope controls to the following settings:

|                 |                  |
|-----------------|------------------|
| Volts/cm:       | 0.2V (X10 probe) |
| Time/cm:        | 1.0 msec         |
| Trigger Mode:   | Automatic        |
| Trigger Source: | Normal           |

4. Connect an insulated female jumper between oscilloscope ground and J050033. Use an insulated female scope probe to connect oscilloscope channel one to the following pins while observing the oscilloscope presentation:

| <u>Pin</u> | <u>Expected Signal</u>        |
|------------|-------------------------------|
| J050066    | Approximately +2.5 to 5 volts |
| J050067    | Approximately +2.5 to 5 volts |
| J050068    | Approximately +2.5 to 5 volts |
| J050069    | Approximately +2.5 to 5 volts |

5. Were all the signals observed in step 4 of a DC level of approximately +2.5 to 5 volts?

No      Yes → Place the service switch in the Off (down) position. Remove and replace A1A4. Go to step 20.

↓

6. Place the service switch in the Off (down) position.
7. Unseat A1A4.
8. Place the service switch in the On (up) position.
9. Repeat step 4.

10. Were all of the signals observed in step 4 now at a DC level of approximately +2.5 to 5 volts?

No      Yes → Place the service switch in the Off (down) position. Remove and replace A1A4. Go to step 20.

↓

11. Place the service switch in the Off (down) position.

11A. Place CBI in the Off (down) position.

12. Reseat A1A4.

13. Unseat A1A2.

13A. Place CBI in the On (up) position.

14. Place the service switch in the On (up) position.

15. Repeat step 4.

16. Were all of the signals observed in step 4 now at a DC level of approximately +2.5 to 5 volts?

No      Yes → Place CBI in the Off (down) position and then place the service switch in the Off (down) position. Remove and replace A1A2. Go to step 19A.

↓

17. Place the service switch in the Off (down) position.

17A. Place CBI in the Off (down) position.

18. Remove and relace A1A5.

19. Reseat A1A2.

19A. Place CBI in the On (up) position.

20. Place the FE local/norm switch in the norm position.

21. Place the service switch in the On (up) position.

22. Place the start/stop switch in the start position and wait for the stack to spin or for '09' to appear in the program code display.

23. Is error code '4B' present in the data display?

No      Yes → Go to Pathfinder Level III, INF 3019.

↓

24. Is any other error code present in the data display?

No      Yes → Consult the error code guide matrix.

↓

25. Place the Massbus enable/disable switch on A1A12 in the enable (up) position.

26. Perform subsystem verification tests.

27. Are there error indications presented?

No      Yes → Use conventional system troubleshooting procedures.

↓

28. Return the disk drive to the customer.



TST 204C

PATHFINDER LEVEL II

TST 204C

**Analog B PCA Test**

You have arrived at this procedure from DIA 0019, step 8. DIA 0019 is still looping.

You are testing the pulser/driver PROM and its associated circuitry for pulse forward and drive forward outputs.

When there is a malfunction in these circuits, error code '4C' appears in the data display.

1. Place the start/stop switch in the stop position.
2. Place the service switch in the Off (down) position.
3. Remove and replace A1A5.
4. Place the FE local/norm switch in the norm position.
5. Place the service switch in the On (up) position.
6. Place the start/stop switch in the start position and wait for the stack to spin or for '09' to appear in the program code display.
7. Is error code '4C' present in the data displays?

No      Yes → Go to Pathfinder Level III, INF 3019.



8. Is any other error code present in the data displays?

No      Yes → Consult the error code matrix guide.



9. Place the Massbus enable/disable switch on A1A12 in the enable (up) position.
10. Perform subsystem verification tests.
11. Are there error indications presented?

No      Yes → Use conventional system troubleshooting procedures.



12. Return the disk drive to the customer.

**Analog B PCA Test**

You have arrived at this procedure from DIA 0019, step 8. DIA 0019 is still looping.

You are testing the pulser/driver PROM and its associated circuitry for pulse reverse and drive reverse outputs.

When there is a malfunction in these circuits, error code '4D' appears in the data display.

1. Place the start/stop switch in the stop position.
2. Place the service switch in the Off (down) position.
3. Remove and replace A1A5.
4. Place the FE local/norm switch in the norm position.
5. Place the service switch in the On (up) position.
6. Place the service switch in the start position and wait for the stack to spin or for '09' to appear in the program code display.
7. Is error code '4D' present in the data displays?

No      Yes → Go to Pathfinder Level III, INF 3019.



8. Is any other error code present in the data displays?

No      Yes → Consult the error code matrix guide.



9. Place the Massbus enable/disable switch on A1A12 in the enable (up) position.
  10. Perform subsystem verification tests.
  11. Are there error indications presented?
- No      Yes → Use conventional system troubleshooting procedures.
12. Return the disk drive to the customer.

TST 204E PATHFINDER LEVEL II TST 204E

EMA Current Sample

You have arrived at this procedure from DIA 0019, step 8; DIA 0019 is still looping.

You are testing the EMA current sample (maximum reverse drive) circuitry.

When there is a malfunction in these circuits, error code '4E' appears in the data display.

1. Set the oscilloscope controls to the following settings:

Volts/cm: 0.2V (X10 probe)  
 Time/cm: 20 msec  
 Trigger Mode: Automatic  
 Trigger Source: Normal

2. Connect an insulated female scope probe to pin J040104 and an insulated female jumper from scope ground to pin J040033.
3. Observe the oscilloscope presentation.

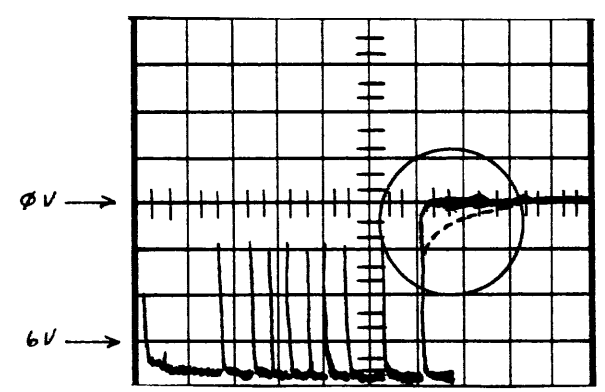

**NOTE**

The negative portion of the signal should be more negative than -4.5 volts (disregard spikes). The return to the 0 volt level should be a sharp 90 degree angle, not a gently curved slope (see circled area of the picture - the signal should not look like the dotted line).

4. Does the oscilloscope presentation look like the waveform illustrated above?

Yes No → Go to step 9.

5. Place the start/stop switch in the stop position.
6. Place the service switch in the Off (down) position.
7. Remove and replace A1A4.
8. Go to step 23.
9. Set the oscilloscope controls to the following settings:

Volts/cm: 2.0V (X10 probe)  
 Time/cm: 1 msec  
 Trigger Mode: Automatic  
 Trigger Source: Normal

10. Connect an insulated female scope probe from oscilloscope channel one to J020111 (-48V servo) and an insulated female jumper between oscilloscope ground and J020127.
11. Observe the oscilloscope presentation.

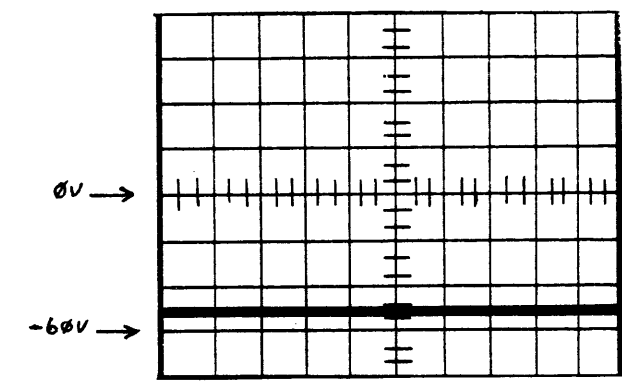

**NOTE**

You are looking for a DC level of approximately -48 volts.

12. Does the oscilloscope presentation look like the waveform illustrated above?

No Yes → Place the start/stop switch in the stop position and then place the service switch in the Off (down) position. Place CB1 in the Off (down) position. Remove and replace A1A2. Place CB1 in the On (up) position and go to step 23.

13. Is CB2 on the back of A1A1 in the On (up) position?

Yes No → Place the start/stop switch in the stop position. Place the service switch in the Off (down) position and then place CB1 in the Off (down) position. Place CB2 in the On (up) position. Place CB1 in the On (Up) position and then place the FE local/norm switch in the norm position. Place the service switch in the On (up) position. Place the start/stop switch in the start position and wait for an '06' or '09' to appear in the program display. If CB2 trips again, go to step 18, else go to step 26.

14. Set the oscilloscope controls to the following settings:

Volts/cm: 0.5V (X10 probe)  
 Time/cm: 20 msec  
 Trigger Mode: Normal  
 Trigger Source: CH 1 (- slope)

15. Connect an insulated female scope probe from oscilloscope channel one to J010107 (-48 control) and an insulated female jumper between oscilloscope ground and J010033.

16. Observe the oscilloscope presentation.

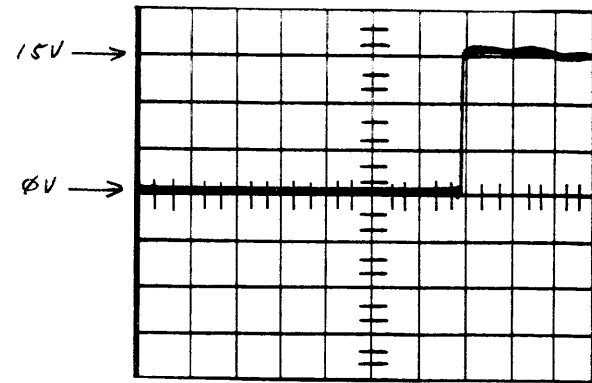

**NOTE**  
You are looking for a signal that switches from approximately 0 volts to approximately +15 volts.

17. Does the oscilloscope presentation look like the waveform illustrated above?

No      Yes → Place the start/stop switch in the stop position and then place the service switch in the Off (down) position. Place CBI in the Off (down) position. Remove and replace A1A1. Place CBI in the On (up) position and go to step 23.

17A. Set the oscilloscope controls to the following settings:

Volts/cm:            0.5V (X10 probe)  
Time/cm:            1 msec  
Trigger Mode:        Automatic  
Trigger Source:      Normal

17B. Connect an insulated female scope probe from oscilloscope channel one to J010109 (+15V) and an insulated female jumper between oscilloscope ground and J010033.

17C. Observe the oscilloscope presentation.

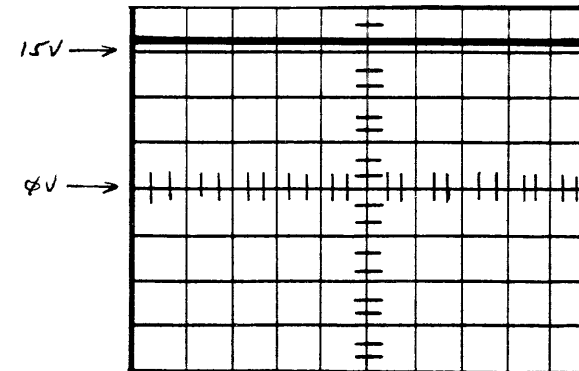

**NOTE**  
You are looking for a DC level of approximately +15 volts.

17D. Does the oscilloscope presentation look like the waveform illustrated above?

Yes      No → Place the start/stop switch in the stop position and then place the service switch in the Off (down) position. Place CBI in the Off (down) position. Remove and replace A1A3. Place CBI in the On (up) position and go to step 23.

17E. Connect an insulated female scope probe from oscilloscope channel one to J020015 and an insulated female jumper between J020033 and oscilloscope ground.

17F. Change the oscilloscope volts/cm to 0.2V (X10 probe) and observe the oscilloscope presentation.

17G. Does the oscilloscope show a DC level of between +2.5 and +5.0 volts?

Yes      No → Place the start/stop switch in the stop position and then place the service switch in the Off (down) position. Remove and replace A1A6 and go to step 23.

18. Place the start/stop switch in the stop position.

19. Place the service switch in the Off (down) position.

20. Place CBI in the Off (down) position.

21. Remove and replace A1A2.

22. Place CBI in the On (up) position.

23. Place the FE local/norm switch in the norm position.

24. Place the service switch in the On (up) position.

25. Place the start/stop switch in the start position.

26. Is error code '4E' present in the data display?

No      Yes → Go to Pathfinder Level III, INF 3019.

27. Is any other error code present in the data display?

No      Yes → Consult the error code guide matrix.

28. Place the Massbus enable/disable switch on A1A12 in the enable (up) position.

29. Perform subsystem verification tests.

30. Are there error indications presented?

No      Yes → Use conventional system troubleshooting procedures.

31. Return the disk drive to the customer.

TST 204F      PATHFINDER LEVEL II      TST 204F

**EMA Current Sample**

You have arrived at this procedure from DIA 0019, step 8; DIA 0019 is still looping.

You are testing the EMA current sample (maximum forward drive) circuitry.

When there is a malfunction in these circuits, error code '4F' appears in the data display.

1. Set the oscilloscope controls to the following settings:

Volts/cm:            0.2V (X10 probe)  
 Time/cm:            20 msec  
 Trigger Mode:        Automatic  
 Trigger Source:      Normal

2. Connect an insulated female scope probe to pin J040104 and an insulated female jumper from scope ground to pin J040033.
3. Observe the oscilloscope presentation.

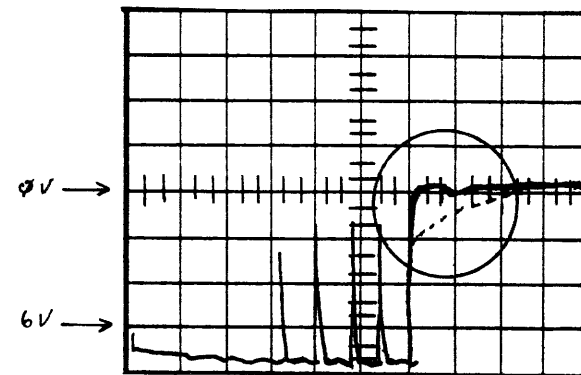

**NOTE**

The negative portion of the signal should be more negative than -4.5 volts (disregard spikes). The return to the 0 volt level should be a sharp 90 degree angle, not a gently curved slope (see circled area of the picture - the signal should not look like the dotted line).

4. Does the oscilloscope presentation look like the waveform illustrated above?
  - Yes      No → Place start/stop to stop. Place service switch Off (down). Place CBI to OFF (down) position. Remove and replace A1A2. Go to step 7.
- 4A. Place the start/stop switch in the stop position.
5. Place the service switch in the Off (down) position.
6. Remove and replace A1A4.
7. Place the FE local/norm switch in the norm position.
8. Place the service switch in the On (up) position.
9. Place the start/stop switch in the start position.
10. Is error code '4F' present in the data display?
  - No      Yes → Go to Pathfinder Level III, INF 3019.
11. Is any other error code present in the data display?
  - No      Yes → Consult the error code guide matrix.
12. Place the Massbus enable/disable switch on A1A12 in the enable (up) position.
13. Perform subsystem verification tests.

14. Are there error indications presented?
  - No
  - Yes → Use conventional system troubleshooting procedures.
15. Return the disk drive to the customer.

## Functional Seek Test

You have arrived at this procedure from the error code guide matrix; POS 0001, step 49; or TST 2051, step 29 or 58.

You are testing the seek circuitry under functional conditions.

When there is a malfunction in these circuits, error code '1B', '1C', '1D', '1E', '44', '45', '46', '47', '50', '51', '52', or '55' appear in the data display.

1. Go to step 2.
2. Set the oscilloscope controls to the following settings:

|                 |                  |
|-----------------|------------------|
| Volts/cm:       | 0.2V (X10 probe) |
| Time/cm:        | 1.0 msec         |
| Trigger Mode:   | Automatic        |
| Trigger Source: | Normal           |

3. Connect an insulated female scope probe from oscilloscope channel one to J060156 (-8.3 servo) and an insulated female jumper between oscilloscope ground and J060033.
4. Observe the oscilloscope presentation.

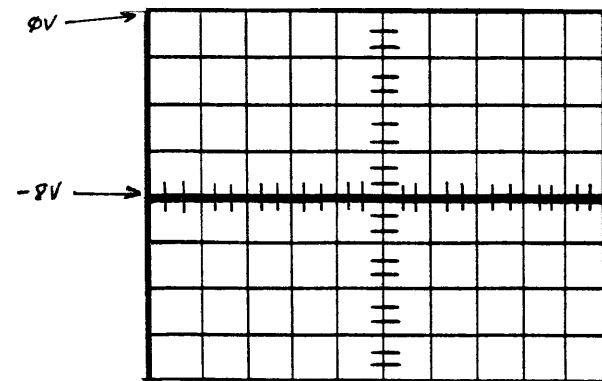
**NOTE**

You are looking for a DC level of  $-8.3 \pm 0.4$  volts.

5. Does the oscilloscope presentation look like the waveform illustrated above?

No      Yes → Go to step 18.

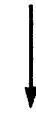

- 5A. Place the start/stop switch in the stop position.
6. Place the service switch in the Off (down) position.
7. Place CBI in the Off (down) position.
8. Unplug the HDA.
9. Place CBI in the On (up) position.
- 9A. Place the service switch in the On (up) position.
10. Place the FE local/norm switch in the local position and wait for CE to appear in the program code display.
- 10A. Enter 'FE'.
- 10B. Depress the enter/step switch.
- 10C. Enter '3E'.
- 10D. Depress the enter/step switch.
- 10E. Enter '11'.
- 10F. Depress the enter/step switch.
11. Now does the oscilloscope presentation look like the waveform illustrated in step 4?

Yes      No → Perform steps 11A through 11E of this procedure. Place service switch Off (down). Place CBI Off (down). Remove and replace A1A06. Plug in the HDA and go to step 14A.



- 11A. Depress the reset button on the FE control panel.
- 11B. Enter '3F' in the Fe panel keyboard.
- 11C. Depress the enter/step switch.
- 11D. Enter '11'.
- 11E. Depress the enter/step switch and wait for the stack to spin down.
12. Place the service switch in the Off (down) position.

13. Place CBI in the Off (down) position.
14. Remove and replace HDA.
- 14A. Place the FE local/norm switch in the norm position.
15. Place CBI in the On (up) position.
- 15A. Place the service switch in the On (up) position.
16. Place the start/stop switch in the start position and wait for the stack to spin.
17. Go to step 72.
18. Set the oscilloscope controls to the following settings:
 

|                 |                  |
|-----------------|------------------|
| Volts/cm:       | 0.5V (X10 probe) |
| Time/cm:        | 0.5 microseconds |
| Trigger Mode:   | Normal           |
| Trigger Source: | CH 1 (- slope)   |
19. Connect an insulated female scope probe from oscilloscope channel one to J060079 (\*servo data) and an insulated female jumper between oscilloscope ground and J060033.
20. Observe the oscilloscope presentation.

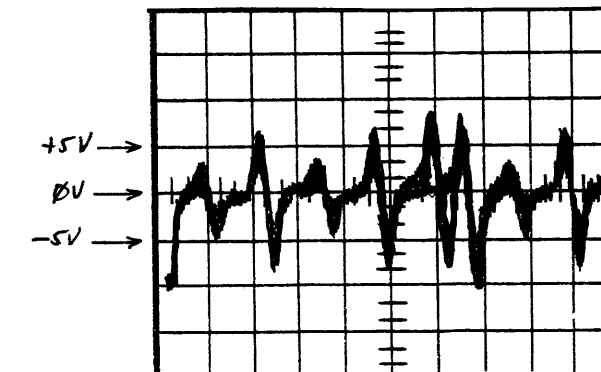
**NOTE**

You are looking for the smaller pulses to be from 5 to 10 volts peak to peak. The signal may jitter.

21. Does the oscilloscope presentation look like the waveform illustrated above?

Yes    No → Place the start/stop switch in the stop position and wait for the stack to stop spinning. Place CBI in the Off (down) position. Remove and replace the HDA and go to step 14A.

↓

- 22. Place the FE local/norm switch in the FE local position.
- 23. Enter 'FE' in the FE panel keyboard.
- 24. Depress the enter/step switch.
- 25. Enter '11' in the FE panel keyboard.
- 26. Depress the enter/step switch.
- 27. Enter '01' in the FE panel keyboard.
- 28. Depress the enter/step switch.
- 29. Enter '01' in the FE panel keyboard.
- 30. Depress the enter/step switch.
- 31. Enter '00' in the FE panel keyboard.
- 32. Depress the enter/step switch.
- 32. You are now attempting to run continuous incremental seeks with one track increments. Let the routine run for a few minutes.

33A. Is there an error code present in the data display?

Yes    No → Go to step 35.

↓

33B. Depress the reset button on the FE panel.

**NOTE**

Steps 33C through 33I read the failing cylinder address from the cylinder address register (CAR).

- 33C. Enter '17'.
- 33D. Depress enter/step.
- 33E. Enter '11' and depress enter/step.
- 33F. Record the data display (low CAR).

33G. Depress enter/step.

33H. Record the data display (high CAR).

33I. Depress reset.

33J. Repeat steps 25 through 33I. If the routine always stops at the same cylinder, allow it to continue to determine if other cylinders will fail. This can be done by depressing the enter/step switch after step 33 instead of performing steps 33B through 33I.

34. Is the failing cylinder address always 000?

Yes    No → Go to step 55.

↓

- 35. Depress the reset button on the FE panel.
- 36. Place the start/stop switch in the stop position and wait for the stack to stop spinning. Place the FE local/norm switch in the norm position.
- 37. Place the service switch in the Off (down) position and then place CBI in the Off (down) position.
- 38. Place CB2 in the Off (down) position.
- 39. Place CBI in the On (up) position and then place the service switch in the On (up) position.
- 40. Place the start/stop switch in the start position and wait for the stack to spin. Disregard any errors displayed in the data display.
- 41. Remove the EMA shipping rod from the storage clip on the front of the baseplate and insert it into the hole in the center of the EMA magnet.

42. Turn the rod clockwise until it is finger tight.

43. Set the oscilloscope controls to the following settings:

|                 |                  |
|-----------------|------------------|
| Volts/cm:       | 0.5V (X10 probe) |
| Time/cm:        | 5 msec           |
| Trigger Mode:   | Normal           |
| Trigger Source: | CH 1 (- slope)   |

44. Connect an insulated female scope probe from oscilloscope channel one to J060129 (\*filtered diff POS) and an insulated female jumper between oscilloscope ground and J060033.

45. Mechanically move the carriage from stop to stop by moving the EMA shipping rod with a smooth steady velocity. Observe the oscilloscope presentation.

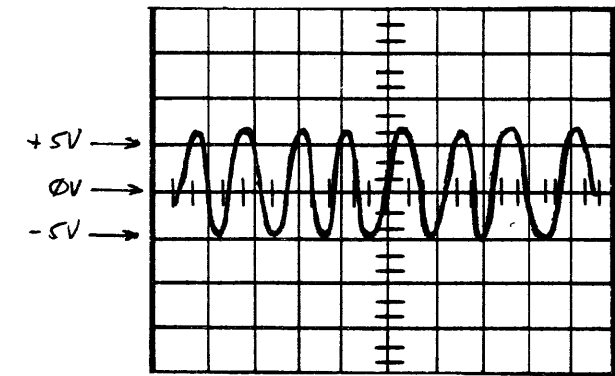

**NOTE**

The waveform should be continuous with no dropouts.

46. Does the oscilloscope presentation look like the waveform illustrated above (no dropouts)?

No    Yes → Turn the EMA shipping rod counterclockwise and remove it from the EMA magnet. Store the rod in the clip provided on the front of the baseplate. Place the start/stop switch in the stop position and then the service switch in the Off (down) position. Remove and replace A1A5. Place the service switch in the On (up) position. Go to step 68.

↓

- 47. Turn the EMA shipping rod counterclockwise and remove it from the EMA magnet. Store the rod in the clip provided on the front of the baseplate.
- 48. Place the start/stop switch in the stop position and wait for the stack to stop spinning.
- 49. Place the service switch in the Off (down) position and then place CBI in the Off (down) position.
- 50. Place CB2 in the On (up) position.
- 51. Remove the replace the HDA.
- 52. Place CBI in the On (up) position and then place the service switch in the On (up) position.

53. Place the start/stop switch in the start position and wait for the stack to spin.

54. Go to step 72.

55. Do the errors occur only on certain cylinders?

Yes      No → Go to step 35.

↓

56. Perform steps 35 through 42 of this procedure, then return to step 57.

57. Slowly move the carriage from stop to stop by moving the shipping rod.

58. Can you feel any binding anywhere along the travel of the carriage?

Yes      No → Go to step 47.

↓

59. Visually check the carriage retainer flap. Is it raised above the carriage tower?

No      Yes → Go to step 61.

↓

60. Is the retainer broken?

No      Yes → Go to step 47.

↓

61. Is the EMA magnet against its alignment pins, both laterally and toward the HDA?

Yes      No → Loosen the mounting bolts and align the magnet (see paragraph 4.2.10 in the service manual). Go to step 65.

↓

62. Are the HDA feet properly seated in the alignment brackets (HDA) pushed to the right as viewed from the rear of the drive).

Yes      No → Correct and go to step 65.

↓

63. With the carriage fully retracted toward the EMA magnet, loosen the crash stop nut and gently rotate the crash stop assembly 180 degrees clockwise. Retighten the nut. Did the carriage binding condition disappear; did the nature of the binding change; or was there resistance to rotating the crash stop assembly?

No      Yes → Remove and replace the crash stop assembly and go to step 65.

↓

64. Physically remove and reinstall the HDA in the machine (see paragraph 4.2.8 in the service manual).

65. Is the carriage still binding?

No      Yes → Go to step 47.

↓

66. Turn the EMA shipping rod counterclockwise and remove it from the EMA magnet. Store the rod in the clip provided on the front of the baseplate.

67. Place the start/stop switch in the stop position and wait for the stack to stop spinning.

68. Place CB1 in the Off (down) position.

69. Place CB2 in the On (up) position.

70. Place CB1 in the On (up) position.

71. Place the start/stop switch in the start position and wait for '06' to appear in the program code display.

72. Place the FE local/norm switch in the FE local position.

73. Enter 'FE' in the FE panel keyboard.

74. Depress the enter/step switch.

75. Enter '12' in the FE panel keyboard.

76. Depress the enter/step switch.

77. Enter '01' in the FE panel keyboard.

78. Depress the enter/step switch.

79. Enter '00' in the FE panel keyboard.

80. Depress the enter/step switch.

81. You are now running continuous random seeks. Let the routine run for a few minutes.

82. Did error code '1C', '1D', '1E', '44', '45', '46', '47', '50', '51', '52', or '55' appear in the data display?

No      Yes → Go to Pathfinder Level III, INF 3050.

↓

83. Did any other error code appear in the data display?

No      Yes → Consult the error code guide matrix.

↓

84. Depress the reset button on the FE control panel.

85. Place the start/stop switch in the stop position and wait for the stack to stop spinning.

86. Place the FE local/norm switch in the norm position.

87. Place the start/stop switch in the start position and wait for the stack to spin.

88. Did error code '1C', '1D', '1E', '44', '45', '46', '47', '50', '51', '52', or '55' appear in the data display?

No      Yes → Go to Pathfinder Level III, INF 3050.

↓

89. Did any other error code present in the data display?

No      Yes → Consult the error code guide matrix.

↓

90. Place the Massbus enable/disable switch on A1A12 in the enable (up) position.

91. Perform subsystem verification tests.

92. Are there error indications presented that indicate a problem in the functional seek circuitry?

No      Yes → Go to Pathfinder Level III, INF 3050.

↓



93. Are there any other error indications presented?

No      Yes → Use conventional system trouble-  
shooting procedures.



94. Return the disk drive to the customer.

**Guard Band Test**

You have arrived at this procedure from the error code guide matrix or from POS 0001, step 48.

You are testing the guard band detection circuitry.

When there is a malfunction in these circuits error code '1D', '44', '45', '4A', or '51' appears in the data display.

1. Place the start/stop switch in the stop position and wait for the stack to stop spinning.
2. Place CB1 in the Off (down) position.
3. Place CB2 in the Off (down) position.
4. Place CBI in the On (up) position.
5. Place the start/stop switch in the start position and wait for the stack to spin. Disregard any error codes displayed on the FE control panel.
6. Remove the EMA shipping rod from its storage clip located on the front of the baseplate. Insert the rod into the hole in the center of the EMA magnet.
7. Turn the shipping rod clockwise until fingertight.
8. Set the oscilloscope controls to the following settings:
 

|                 |                   |
|-----------------|-------------------|
| CH 1 volts/cm:  | 0.2 V (X10 probe) |
| Time/cm:        | 50 microseconds   |
| Trigger Mode:   | Normal            |
| Trigger Source: | CH 1 (- slope)    |
9. Connect an insulated female scope probe from oscilloscope channel one to J060026 (- guard band 1) and an insulated female jumper between oscilloscope ground and J060033.
10. Mechanically move the carriage to the forward stop by pushing the EMA shipping rod all the way in and holding it there. Observe the oscilloscope presentation.

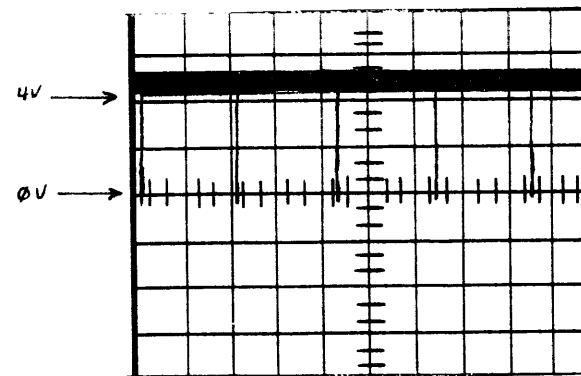
**NOTE**

You are looking for negative pulses to be present.

11. Does the oscilloscope presentation look like the waveform illustrated above?
 

|     |    |                  |
|-----|----|------------------|
| Yes | No | → Go to step 49. |
|-----|----|------------------|
12. Connect an insulated female scope probe from oscilloscope channel one to J060028 (-guard band 2) and an insulated female jumper between oscilloscope ground and J060033.
- 12A. Mechanically move the carriage to the reverse stop by pulling the EMA shipping rod all the way out and holding it there. Observe the oscilloscope presentation.
- 12B. Does the oscilloscope presentation look like the waveform illustrated in step 10?
 

|     |    |                  |
|-----|----|------------------|
| Yes | No | → Go to step 49. |
|-----|----|------------------|
13. Place the start/stop switch in the stop position and wait for the stack to stop spinning.
14. Turn the EMA shipping rod counterclockwise and remove it from the EMA coil. Store the rod on the clip provided on the front of the baseplate.
15. Place CB1 in the Off (down) position.

16. Place CB2 in the On (up) position.
17. Place CBI in the On (up) position.
18. Place the start/stop switch in the start position and wait for the stack to spin.
19. Place the FE Local/norm switch in the FE local position.
20. Enter 'FE' in the FE panel keyboard.
21. Depress the enter/step switch.
22. Enter '12' in the FE panel keyboard.
23. Depress the enter/step switch.
24. Enter '01' in the FE panel keyboard.
25. Depress the enter-step switch.
26. Enter '00' in the FE panel keyboard.
27. Depress the enter/step switch.
28. You are now running continuous random seeks. Let the routine run for a few minutes. If the routine stops with an error, record the error code displayed in the data display and depress the enter/step switch to continue.
29. Did any error codes appear other than '1D', '44', '45', '4A', or '51'?
 

|    |     |                  |
|----|-----|------------------|
| No | Yes | → Go to TST 2050 |
|----|-----|------------------|
30. Push the reset button on the FE control panel.
31. Place the start/stop switch in the stop position and wait for the stack to stop spinning.
32. Place the service switch in the Off (down) position.
33. Remove and replace A1A5.
34. Place the service switch in the On (up) position.
35. Perform steps 18 through 27 for this procedure.
36. You are now running continuous random seeks. Let the routine run for a few minutes.

37. Did error code '1D', '44', '45', '4A', or '51' appear in the data display?

No Yes → Go to Pathfinder Level III, INF 3050.



38. Did any other error code appear in the data display?

No Yes → Consult the error code guide matrix.



39. Push the reset button on the FE control panel.

40. Place the start/stop switch in the stop position and wait for the stack to stop spinning.

41. Place the FE local/norm switch in the norm position.

42. Place the start/stop switch in the start position and wait for the stack to spin.

43. Did error code '1D', '44', '45', '4A', or '51' appear in the data display?

No Yes → Go to Pathfinder Level III, INF 3050.



44. Did any other error code appear in the data display?

No Yes → Consult the error code guide matrix.



45. Place the Massbus enable/disable switch on A1A12 in the enable (up) position and

46. Perform subsystem verification tests.

47. Are there any errors presented that indicate a problem in the guard band circuitry?

No Yes → Go to Pathfinder level III, INF 3050.



48. Are there any other error indications presented?

No Yes → Use conventional system troubleshooting procedures.



48A. Return the disk drive to the customer.

49. Set the oscilloscope controls to the following settings:

|                 |                  |
|-----------------|------------------|
| Volts/cm:       | 0.5V (X10 probe) |
| Time/cm:        | 5 milliseconds   |
| Trigger Mode:   | Normal           |
| Trigger Source: | CH 1 (- slope)   |

50. Connect an insulated female scope probe from oscilloscope channel one to J060129 (\*filtered diff POS) and an insulated female jumper between oscilloscope ground and J060033.

51. Mechanically move the carriage from stop to stop by moving the EMA shipping rod with a smooth steady velocity. Observe the oscilloscope presentation.

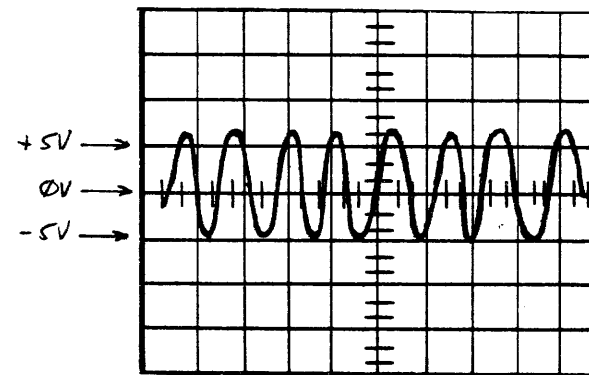

**NOTE**

The waveform should be continuous with no dropouts.

52. Does the oscilloscope presentation look like the waveform illustrated above?

No Yes → Go to step 31.



53. Place the start/stop switch in the stop position and wait for the stack to stop spinning.

54. Turn the EMA shipping rod counterclockwise and remove it from the EMA coil. Store the rod on the clip provided on the front of the baseplate.

55. Place CBI in the Off (down) position.

56. Place CB2 in the On (up) position.

57. Place CBI in the On (up) position.

58. Go to TST 2050.

## PLO UNSAFE2 TEST

You have arrived at this procedure from DIA 0001, step 6.

You are testing the PLO UNSAFE2 circuitry.

When there is a malfunction in these circuits, error code '53' appears in the data display.

1. Connect an insulated female scope probe from oscilloscope channel one to J040137 (+WR OSC/64) and an insulated female jumper between oscilloscope ground and J040127.
2. Set the oscilloscope controls to the following settings:

|                 |                   |
|-----------------|-------------------|
| Volts/cm:       | 0.2 V (X10 probe) |
| Time/cm:        | 1.0 microsecond   |
| Trigger Mode:   | Normal            |
| Trigger Source: | CH 1 (+ slope)    |

3. Observe the oscilloscope presentation.

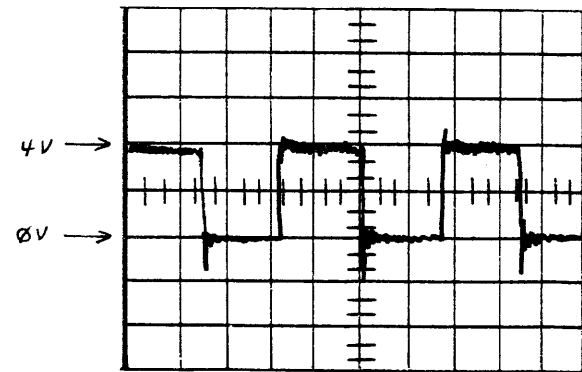
**NOTE**

You are looking for symmetrical pulses 1.7 usec wide (negative and positive).

4. Does the oscilloscope presentation look like the waveform illustrated above?

No      Yes → Go to step 5.



- 4A. Place the start/stop switch in the stop position.
- 4B. Place the service switch in the Off (down) position.
- 4C. Unseat A1A4.
- 4D. Place the service switch in the On (up) position.
- 4E. Now does the oscilloscope presentation look like the waveform illustrated in step 3?

No      Yes → Place the service switch in the Off (down) position. Remove and replace A1A4. Go to step 12.



- 4F. Place the service switch in the Off (down) position.
- 4G. Reseat A1A4.
- 4H. Remove and replace A1A6.
- 4I. Go to step 12.

5. Connect an insulated female scope probe from oscilloscope channel one to J040151 (-PLO UNSAFE2) and an insulated female jumper between oscilloscope ground and J040127.

6. Set the oscilloscope controls to the following settings:

|                 |                   |
|-----------------|-------------------|
| Volts/cm:       | 0.2 V (X10 probe) |
| Time/cm:        | 1.0 millisecond   |
| Trigger Mode:   | Automatic         |
| Trigger Source: | Normal            |

7. Observe the oscilloscope presentation.

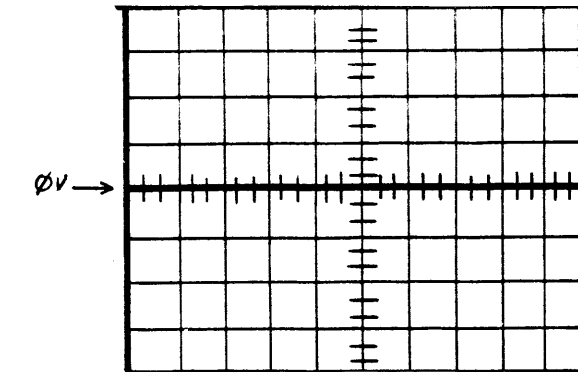
**NOTE**

You are looking for a DC Level of approximately zero volts.

8. Does the oscilloscope presentation look like the waveform illustrated above?

Yes      No → Place the start/stop switch in the stop position and then the service switch in the Off (down) position. Remove and replace A1A6. Go to step 12.



9. Place the start/stop switch in the stop position.
10. Place the service switch in the Off (down) position.
11. Remove and replace A1A4.
12. Place the FE local/norm switch in the norm position.
13. Place the service switch in the On (up) position.
14. Place the start/stop switch in the start position and wait for the stack to spin or for '09' to appear in the program code display.

15. Is error code '53' present in the data display?  
No      Yes → Go to Pathfinder level III, INF 3053.



16. Is any other error code present in the data display?  
No      Yes → Consult the error code guide matrix.



17. Place the Massbus enable/disable switch on A1A12 in the enable (up) position.

18. Perform subsystem verification tests.

19. Are there error indications presented?

No      Yes → Use conventional system troubleshooting procedures.



20. Return the disk drive to the customer.

**EMA Current Offset Calibration**

You have arrived at this procedure from DIA 0019, step 8. DIA 0019 is still looping.

You are testing the EMA current offset calibration circuitry.

When there is a malfunction in these circuits, error code '54' appears in the data display.

1. Set the oscilloscope controls to the following settings:

|                 |                   |
|-----------------|-------------------|
| Volts/cm:       | 20 mV (X10 probe) |
| Time/cm:        | 50 milliseconds   |
| Trigger Mode:   | Automatic         |
| Trigger Source: | Normal            |

2. Connect an insulated female scope probe to PIN J040104 and an insulated female jumper from scope GND to PIN J040033.
3. Observe the oscilloscope presentation.

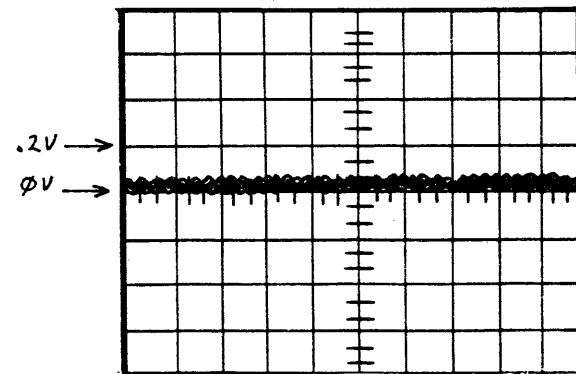

**NOTE**  
You are looking for a DC level of +0.5 volts or less.

4. Does the scope presentation look like the waveform illustrated above?

No      Yes → Place service switch Off. Remove and replace A1A4. Go to step 9.

5. Connect an insulated female scope probe to PIN J020083 and an insulated female jumper from scope GND to PIN J020033.

- 5A. Set the oscilloscope controls to the following settings:

|                 |                  |
|-----------------|------------------|
| Volts/cm:       | 0.1V (X10 probe) |
| Time/cm:        | 1.0 millisecond  |
| Trigger Mode:   | Automatic        |
| Trigger Source: | Normal           |

6. Observe the oscilloscope presentation.

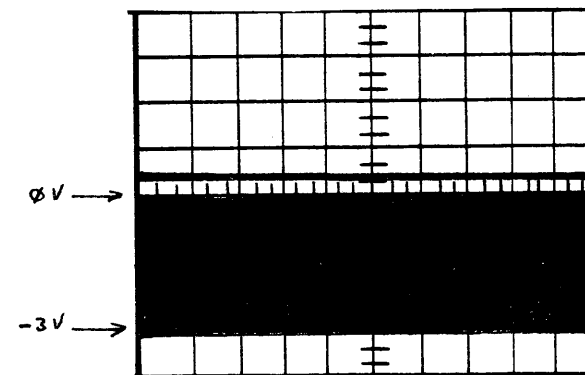
**NOTE**

You are looking for a DC level to vary from 0 volts to -3 volts in 0.1 volt increments. There may also be a DC level of +0.4 volts.

7. Does the oscilloscope presentation look like the waveform illustrated above?

No      Yes → Place service switch off. Place CBI to OFF (down) position. Remove and replace A1A2. Go to step 9.

8. Place service switch off.
  - 8A. Remove and replace A1A4.
  9. Place the FE local/norm switch in the norm position.
  10. Place the service switch in the up (On) position.
  11. Place the start/stop switch in the start position.
  12. Is error code '54' present in the data display?
- No      Yes → Go to Pathfinder Level III, INF 3019.
13. Is any other error code present in the data display?
- No      Yes → Consult the error code guide matrix.
14. Place the Massbus enable/disable switch on A1A12 in the enable (up) position.
  15. Perform subsystem verification tests.
  16. Are there error indications presented?
- No      Yes → Use conventional system troubleshooting procedures.
17. Return the disk drive to the customer.

**EMA Current Offset Calibration**

You have arrived at this procedure from DIA 0019, step 8. DIA 0019 is still looping.

You are testing the EMA current calibration circuitry.

When there is a malfunction in these circuits, error code '56' appears in the data display.

1. Set the oscilloscope controls to the following settings:

Volts/cm: 20 mV (X10 probe)  
 Time/cm: 50 milliseconds  
 Trigger Mode: Automatic  
 Trigger Source: Normal

2. Connect an insulated female scope probe to PIN J040104 and an insulated female jumper from scope GND to PIN J020033.
3. Observe the oscilloscope presentation.

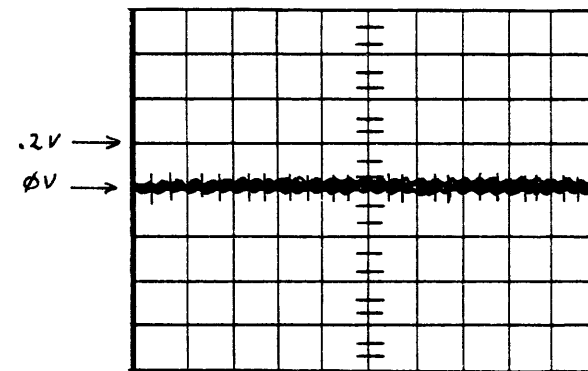

**NOTE**  
 The signal value should not be more negative than -.5 volts.

4. Does the oscilloscope presentation look like the waveform illustrated above?

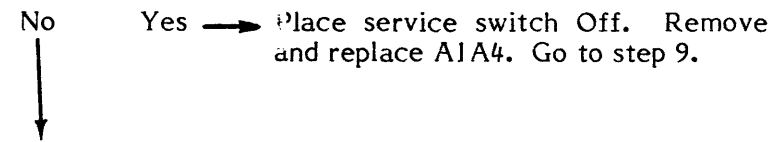

5. Connect an insulated female scope probe to PIN J020083 and an insulated female jumper from scope GND to PIN J040033.

- 5A. Set the oscilloscope controls to the following settings:

Volts/cm: 0.1V (X10 probe)  
 Time/cm: 1.0 millisecond  
 Trigger Mode: Automatic  
 Trigger Source: Normal

6. Observe the oscilloscope presentation.

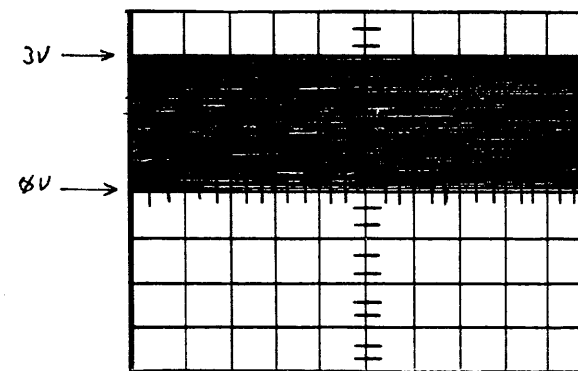

**NOTE**  
 You are looking for a DC level to vary from 0 volts to +3.0 volts in 0.1 volt increments.

7. Does the oscilloscope presentation look like the waveform illustrated above?

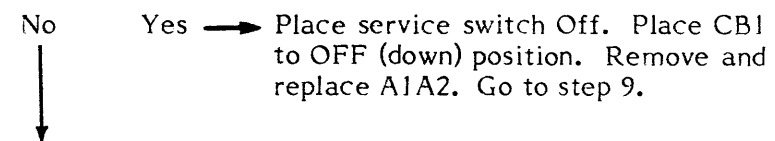

8. Place the service switch in the down (Off) position.
- 8A. Remove and replace A1A4.
9. Place the FE local/norm switch in the norm position.
10. Place the service switch in the up (On) position.
11. Place the start/stop switch in the start position.
12. Is error code '56' present in the data display?

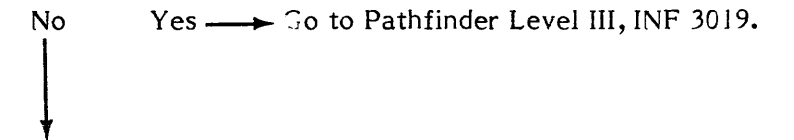

13. Is any other error code present in the data display?

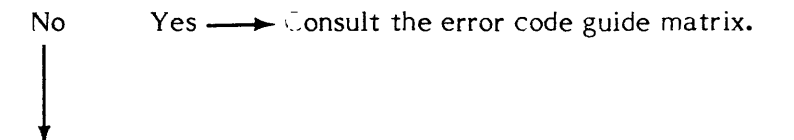

14. Place the Massbus enable/disable switch on A1A12 in the enable (up) position.
15. Perform subsystem verification tests.
16. Are there error indications presented?

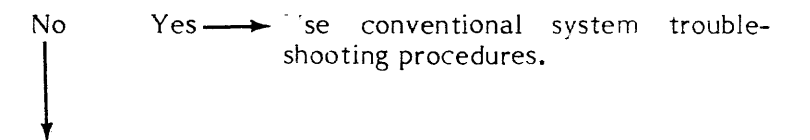

17. Return the disk drive to the customer.

**\* Curve D/A <300mV**

You have arrived at this procedure from DIA 0033, step 9. DIA 0033 is still looping.

You are testing the curve D/A <300 millivolts circuitry on the A1A5 PCA.

When there is a malfunction in these circuits, error code '57' appears in the data display.

1. Set the oscilloscope controls to the following settings:

|                 |                   |
|-----------------|-------------------|
| Volts/cm:       | 50 mV (X10 probe) |
| Time/cm:        | 50 milliseconds   |
| Trigger Mode:   | Automatic         |
| Trigger Source: | Normal            |

2. Connect an insulated female scope probe from oscilloscope channel one to J050081 (\*Curve DA) and an insulated female jumper between oscilloscope ground and J050033.
3. Observe the oscilloscope presentation.

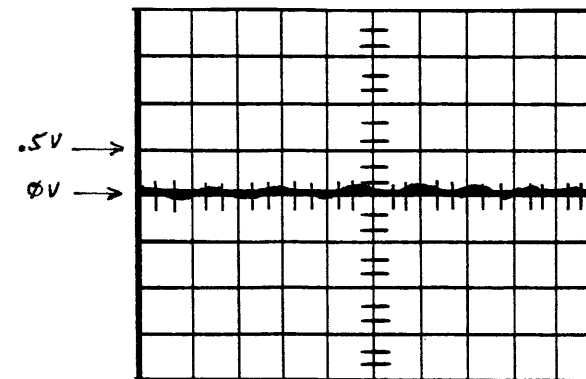
**NOTE**

You are looking for a DC level of less than 300 millivolts.

4. Does the oscilloscope presentation look like the waveform illustrated above?

No      Yes → Place the service switch in the Off (down) position. Remove and replace A1A4. Go to step 7.

5. Place the service switch in the Off (down) position.
6. Remove and replace A1A5.
7. Place the FE local/norm switch in the norm position.
8. Place the service switch in the On (up) position.
9. Place the start/stop switch in the start position.
10. Is error code '57' present in the data display?

No      Yes → Go to Pathfinder Level III, INF 3033.

11. Is any other error code present in the data display?

No      Yes → Consult the error code guide matrix.

12. Place the Massbus enable/disable switch on A1A12 in the enable (up) position.
13. Perform subsystem verification tests.
14. Are there error indications presented?

No      Yes → Use conventional system troubleshooting procedures.

15. Return the disk drive to the customer.



**TST 2058                      PATHFINDER LEVEL II                      TST 2058**

**Curve Generator >-300 Millivolts Test**

You have arrived at this procedure from DIA 0033, step 9. DIA 0033 is still looping.

You are testing the curve generator >-300 mV circuitry on the A1A5 PCA.

When there is a malfunction in these circuits, error code '58' appears in the data display.

1. Set the oscilloscope controls to the following settings:

|                 |                  |
|-----------------|------------------|
| Volts/cm:       | 50mV (X10 probe) |
| Time/cm:        | 50 milliseconds  |
| Trigger Mode:   | Automatic        |
| Trigger Source: | Normal           |

2. Connect an insulated female scope probe from oscilloscope channel one to J050084 (\*Curve GEN) and an insulated female jumper between oscilloscope ground and J050033.
3. Observe the oscilloscope presentation.

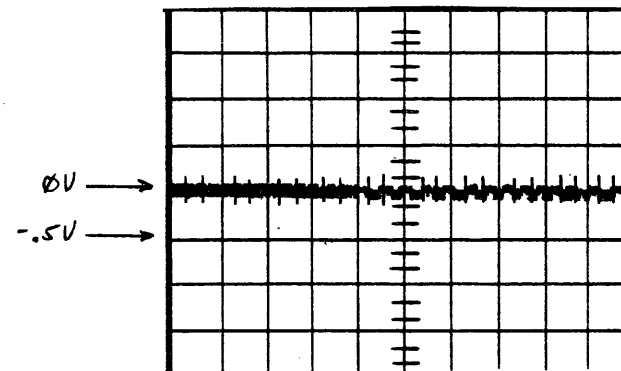

**NOTE**  
 You are looking for a DC level to be less negative than -0.2 volts.

4. Does the oscilloscope presentation look like the waveform illustrated above?
  - No                      Yes → Place the service switch in the Off (down) position. Remove and replace A1A4. Go to step 7.
5. Place the service switch in the Off (down) position.
6. Remove and replace A1A5.
7. Place the FE local/norm switch in the norm position.
8. Place the service switch in the On (up) position.
9. Place the start/stop switch in the start position.
10. Is error code '58' present in the data display?
  - No                      Yes → Go to Pathfinder Level III, INF 3033.
11. Is any other error code present in the data display?
  - No                      Yes → Consult the error code guide matrix.
12. Place the Massbus enable/disable switch on A1A12 in the enable (up) position.
13. Perform subsystem verification tests.
14. Are there error indications presented?
  - No                      Yes → Use conventional system troubleshooting procedures.
15. Return the disk drive to the customer.

**Curve Generator TP More Negative Than -1.1 V**

You have arrived at this procedure from DIA 0033, step 9. DIA 0033 is still looping.

You are testing that the curve generator TP is more negative than -1.1 volts on A1A5.

When there is a malfunction in these circuits, error code '59' appears in the data display.

1. Set the oscilloscope controls to the following settings:

|                 |                   |
|-----------------|-------------------|
| Volts/cm:       | 50 mV (X10 probe) |
| Time/cm:        | 50 milliseconds   |
| Trigger Mode:   | Normal            |
| Trigger Source: | CH 1 (- slope)    |

2. Connect an insulated female scope probe to PIN J050084 and an insulated female jumper from scope ground to PIN J050033.
3. Observe the oscilloscope presentation.

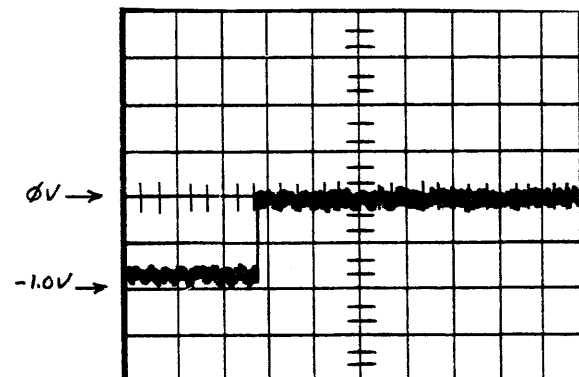
**NOTE**

You are looking for the negative portion of the signal to be no more negative than -1.1 volts.

4. Does the scope presentation look like the waveform illustrated above?

No      Yes → Place the service switch Off.  
Remove and replace A1A4. Go to step 7.

5. Place the service switch in the down (Off) position.
6. Remove and replace A1A5.
7. Place the FE local/norm switch in the norm position.
8. Place the service switch in the up (On) position.
9. Place the start/stop switch in the start position.
10. Is error code '59' present in the data display?

No      Yes → Go to Pathfinder Level III, INF 3033.

11. Is any other error code present in the data display?

No      Yes → Consult the error code guide matrix.

12. Place the Massbus enable/disable switch on A1A12 in the enable (up) position.
13. Perform subsystem verification tests.
14. Are there error indications presented?

No      Yes → Use conventional system troubleshooting procedures.

15. Return the disk drive to the customer.

## TST 205A      PATHFINDER LEVEL II      TST 205A

**Curve Generator TP <-0.6V (DIFF = 000A HEX)**

You have arrived at this procedure from DIA 0033, step 9. DIA 0033 is still looping.

You are testing the curve generator TP <-0.6V (DIFF = 000A HEX) circuitry.

When there is a malfunction in these circuits, error code '5A' appears in the data display.

1. Set the oscilloscope controls to the following settings:

|                 |                   |
|-----------------|-------------------|
| Volts/cm:       | 50 mV (X10 probe) |
| Time/cm:        | 50 milliseconds   |
| Trigger Mode:   | Normal            |
| Trigger Source: | CH 1 (- slope)    |

2. Connect an insulated female scope probe to PIN J050084 and an insulated female jumper from scope ground to PIN J050033.
3. Observe the oscilloscope presentation.

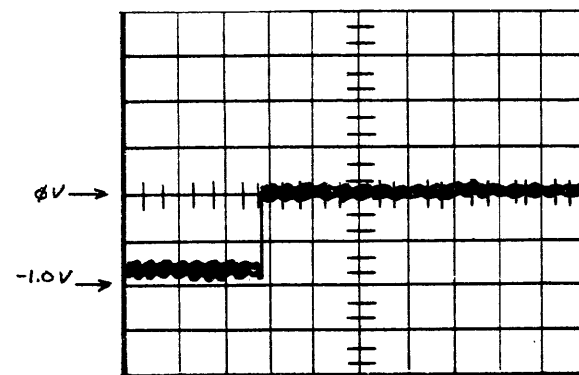
**NOTE**

You are looking for the negative portion of the signal to be -0.5 volts or more negative.

4. Does the scope presentation look like the waveform illustrated above?

No      Yes → Please the service switch Off.  
Remove and replace A1A4. Go to step 7.

5. Place the service switch in the down (Off) position.
6. Remove and replace A1A5.
7. Place the FE local/norm switch in the norm position.
8. Place the service switch in the up (On) position.
9. Place the start/stop switch in the start position.
10. Is error code '5A' present in the data display?

No      Yes → Go to Pathfinder Level III, INF 3033.

11. Is any other error code present in the data display?

No      Yes → Consult the error code guide matrix.

12. Place the Massbus enable/disable switch on A1A12 in the enable (up) position.
13. Perform subsystem verification tests.
14. Are there error indications presented?

No      Yes → Use conventional system troubleshooting procedures.

15. Return the disk drive to the customer.

**\*Curve D/A >500 Millivolts (DIFF = 000A HEX)**

You have arrived at this procedure from DIA 0033, step 9. DIA 0033 is still looping.

You are testing the \*Curve D/A >500 millivolts (DIFF = 000A HEX) circuitry.

When there is a malfunction in these circuits, error code '5B' appears in the data display.

1. Set the oscilloscope controls to the following settings:

|                 |                   |
|-----------------|-------------------|
| Volts/cm:       | 50 mV (X10 probe) |
| Time/cm:        | 50 milliseconds   |
| Trigger Mode:   | Normal            |
| Trigger Source: | CH 1 (- slope)    |

2. Connect an insulated female scope probe to PIN J050081 and an insulated female jumper from scope ground to PIN J050033.
3. Observe the oscilloscope presentation.

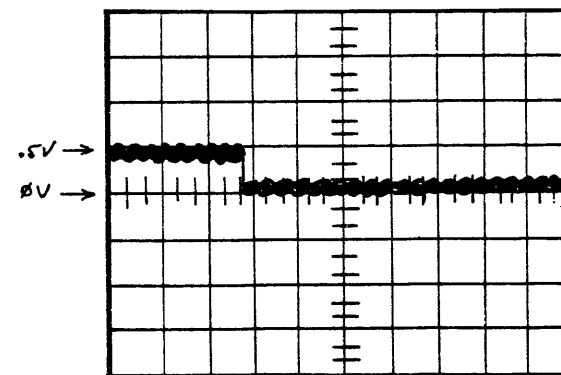
**NOTE**

You are looking for the positive going pulse to be less than 0.5 volts.

4. Does the scope presentation look like the waveform illustrated above?

No      Yes → Place the service switch Off. Remove and replace A1A4. Go to step 7.

5. Place the service switch in the down (Off) position.

6. Remove and replace A1A5

7. Place the FE local/norm switch in the norm position.

8. Place the service switch in the up (On) position.

9. Place the start/stop switch in the start position.

10. Is error code '5B' present in the data display?

No      Yes → Go to Pathfinder Level III, INF 3033.

11. Is any other error code present in the data display?

No      Yes → Consult the error code guide matrix.

12. Place the Massbus enable/disable switch on A1A12 in the enable (up) position.

13. Perform subsystem verification tests.

14. Are there error indications presented?

No      Yes → Use conventional system troubleshooting procedures.

15. Return the disk drive to the customer.

TST 205C                      PATHFINDER LEVEL II                      TST 205C

**\*Curve D/A >250 Millivolts (DIFF = 000A Hex)**

You have arrived at this procedure from DIA 0033, step 9. DIA 0033 is still looping.

You are testing the \*Curve D/A >250 millivolts (DIFF = 000A HEX) circuitry.

When there is a malfunction in these circuits, error code '5C' appears in the data display.

1. Set the oscilloscope controls to the following settings:

Volts/cm:                      50 mV (X10 probe)  
 Time/cm:                      50 milliseconds  
 Trigger Mode:                Normal  
 Trigger Source:              CH 1 (- slope)

2. Connect an insulated female scope probe to PIN J050081 and an insulated female jumper from scope ground to PIN J050033.
3. Observe the oscilloscope presentation.

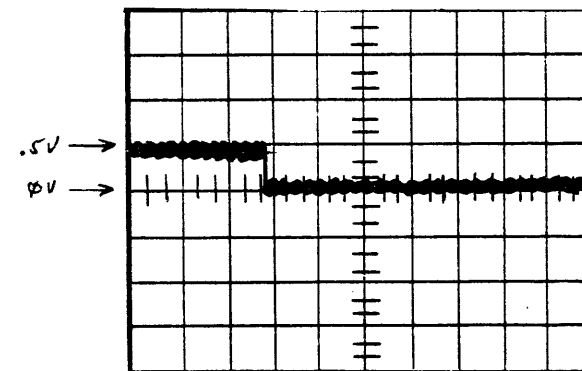

**NOTE**

You are looking for the positive going pulse to .25 volts or greater.

4. Does the scope presentation look like the waveform illustrated above?

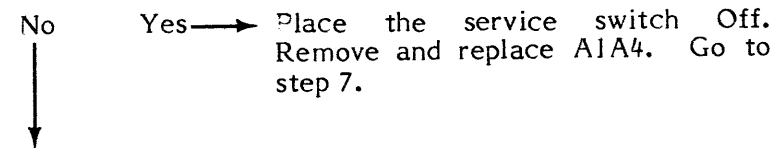

5. Place the service switch in the down (Off) position.
6. Remove and replace A1A5.
7. Place the FE local/norm switch in the norm position.
8. Place the service switch in the up (On) position.
9. Place the start/stop switch in the start position.
10. Is error code '5C' present in the data display?

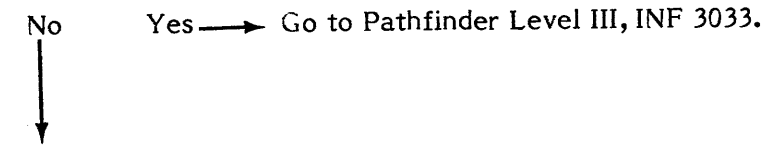

11. Is any other error code present in the data display?

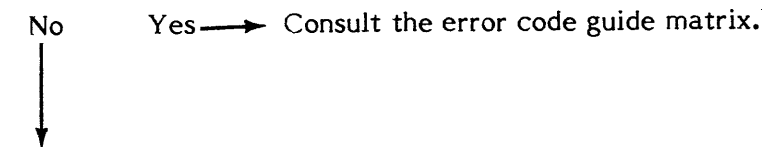

12. Place the Massbus enable/disable switch on A1A12 in the enable (up) position.
13. Perform subsystem verification tests.
14. Are there error indications presented?

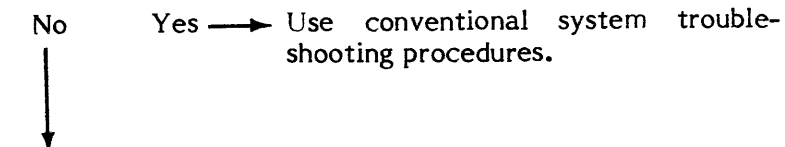

15. Return the disk drive to the customer.

**\*Curve D/A < 9.75V (DIFF = 007F HEX)**

You have arrived at this procedure from DIA 0033, step 9. DIA 0033 is still looping.

You are testing the \*Curve D/A < 9.75V (DIFF = 007F HEX) circuitry.

When there is a malfunction in these circuits, error code '5D' appears in the data display.

1. Set the oscilloscope controls to the following settings:

|                 |                  |
|-----------------|------------------|
| Volts/cm:       | .5 V (X10 probe) |
| Time/cm:        | 50 milliseconds  |
| Trigger Mode:   | Normal           |
| Trigger Source: | CH 1 (+ slope)   |

2. Connect an insulated female scope probe to PIN J050081 and an insulated female jumper from scope ground to PIN J050033.
3. Observe the oscilloscope presentation.

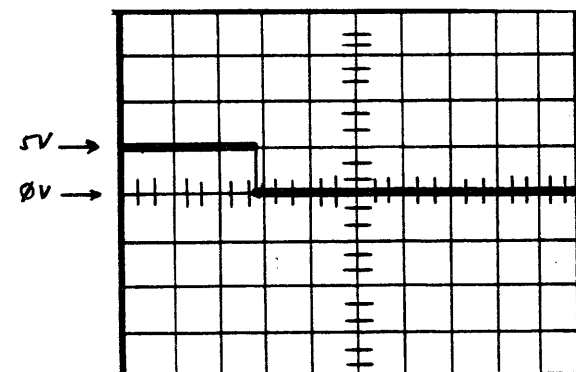
**NOTE**

You are looking for the positive portion of the signal to be less than 9.75 volts.

4. Does the scope presentation look like the waveform illustrated above?

No      Yes → Place the service switch Off.  
Remove and replace A1A4. Go to step 8.

5. Place the service switch in the down (Off) position.
6. Remove and replace A1A5.
7. Place the FE local/norm switch in the norm position.
8. Place the service switch in the up (On) position.
9. Place the start/stop switch in the start position.
10. Is error code '5D' present in the data display?

No      Yes → Go to Pathfinder Level III, INF 3033.

11. Is any other error code present in the data display?

No      Yes → Consult the error code guide matrix.

12. Place the Massbus enable/disable switch on A1A12 in the enable (up) position.
13. Perform subsystem verification tests.
14. Are there error indications presented?

No      Yes → Use conventional system troubleshooting procedures.

15. Return the disk drive to the customer.

## TST 202F                      PATHFINDER LEVEL II                      TST 202F

**Filtered Diff POS within -0.5V Window (Test Osc On Track)**

You have arrived at this procedure from DIA 0031, step 9; DIA 0031 is still looping.

You are testing that the filtered difference position is within the -0.5V window.

When there is a malfunction in these circuits, error code '2F' appears in the data display.

1. Set the oscilloscope controls to the following settings:

|                 |                 |
|-----------------|-----------------|
| Volts/cm:       | .1V (X10 probe) |
| Time/cm:        | 50 msec         |
| Trigger Mode:   | Normal          |
| Trigger Source: | CH 1 (- slope)  |

2. Connect an insulated female scope probe to pin J040102 and an insulated female jumper from scope ground to pin J040033.
3. Observe the oscilloscope presentation.

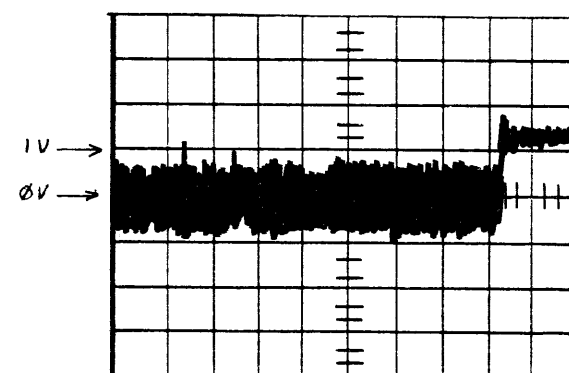
**NOTE**

You are looking for a DC level of from 0 to -0.5 volts of the grassy portion of the trace (disregard pulses).

4. Does the oscilloscope presentation look like the waveform illustrated above?

No            Yes → Turn the service switch in the Off position. Remove and replace A1A4. Go to step 7.

5. Place the service switch in the Off (down) position.
6. Remove and replace A1A5.
7. Place the FE local/norm switch in the norm position.
8. Place the service switch in the On (up) position.
9. Place the start/stop switch in the start position.
10. Is error code '2F' present in the data display?

No            Yes → Go to Pathfinder Level III, INF 3031.

11. Is any other error code present in the data display?

No            Yes → Consult the error code guide matrix.

12. Place the Massbus enable/disable switch on A1A12 in the enable (up) position.
13. Perform subsystem verification tests.
14. Are there error indications presented?

No            Yes → Use conventional system troubleshooting procedures.

15. Return the disk drive to the customer.